

LED间隔柱

LED SPACER SUPPORT

电子电脑塑胶五金零件

PLASTIC HARDWARE & ELECTRONIC COMPONENTS

2024 EDITON

LED间隔柱介绍

LED间隔柱,也称LED隔离柱,垫高灯柱,英文名称LED Spacer Support,把LED固定在PCB板上,高度一致,不断脚。广泛应用于视频管,显示屏产品,用途是作为RGB间隔,采用2R1G1B的方式。进入21世纪,LED产品发展迅猛,对LED间隔柱的需求也日趋复杂,为配合LED灯,间隔柱高度一般以0.5毫米为一个基准,从1毫米到25毫米共分为50个不同高度,使得LED间隔柱产品型号异常繁多。

分类

按外形划分,主要分为双坑间隔柱和圆形间隔柱,四方间隔柱三种。

A: 双坑间隔柱: 特点是在左右二侧各留一条槽,供二极管管脚压紧。

B: 圆孔间隔柱: 针脚插入间隔柱预留的二个方形孔中,不裸露在外。

C: 四方孔间隔柱: 又分为一孔二孔多孔等规格,特点是针脚与LED灯成九十度折弯,方便特殊情况下的安装。

其中应用最广泛的是圆形间隔柱,按照LED灯直径又分为 $\phi 3$ $\phi 4$ $\phi 5$ $\phi 7$ 四个系列,每系列以0.5毫米高度为一个不同型号,约有超过四百种规格。按圆形间隔柱内嵌孔形状还分为方孔,圆孔,小孔三个系列。

类型详解

双坑间隔柱

双坑间隔柱。led间隔柱其中一种类型,左右二侧各留一条槽,供二极管管脚压紧。主要用于保护LED立于PC板上,接脚不会弯曲,折断,且使LED高度一致,免用治具,尺寸齐全,不占空间. 装配快捷美观。

圆孔间隔柱

圆孔间隔柱,又称圆形隔离柱。针脚插入间隔柱预留的二个方形孔中,不裸露在外。主要用于使LED立于PC板上,高度一致,不碰脚,不短路。

四方孔间隔柱

四方孔间隔柱,又称led方形座. 针脚与LED灯成九十度折弯,方便特殊情况下的安装。主要用于使LED成 90° 立于PC板上,高度一致,不断脚,不短路,整齐美观。

LED间隔柱 / LED隔离柱 / 垫高灯柱 / LED SPACER SUPPORT

LED间隔柱

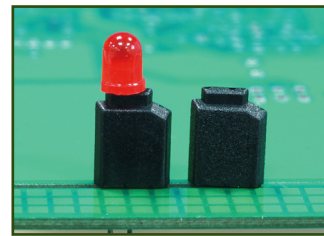
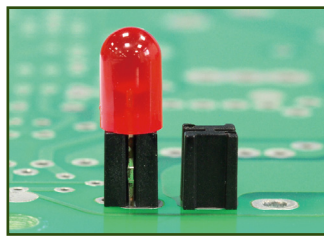
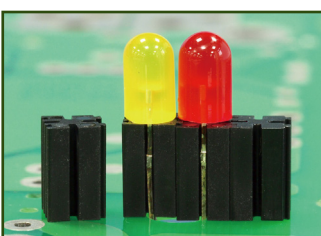
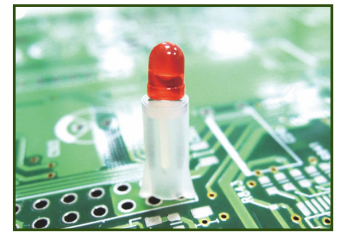
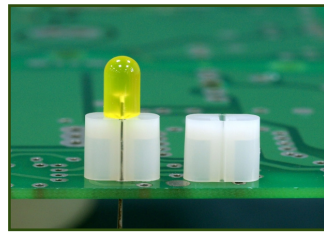
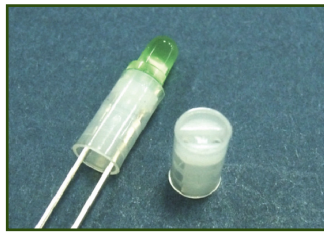
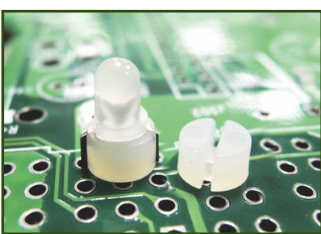
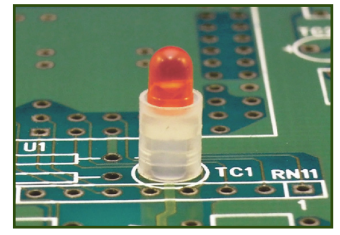
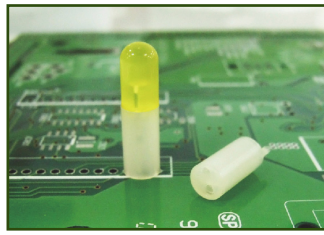
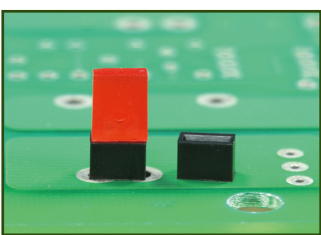
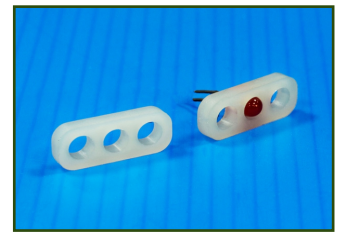
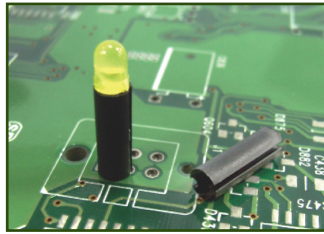
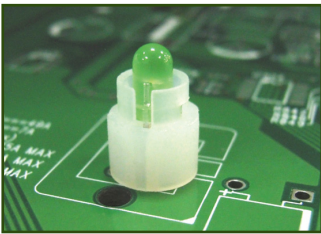
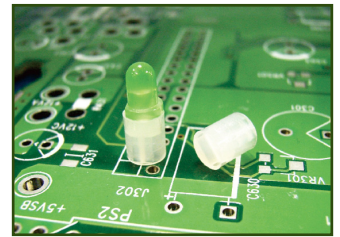
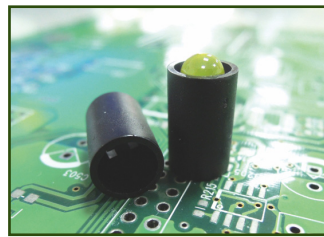
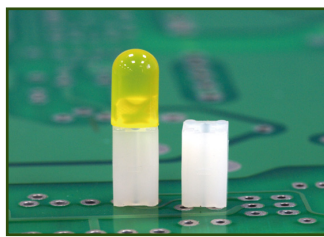
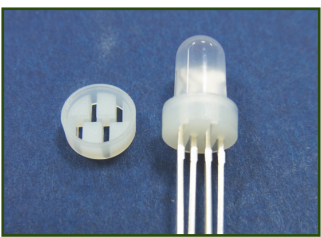
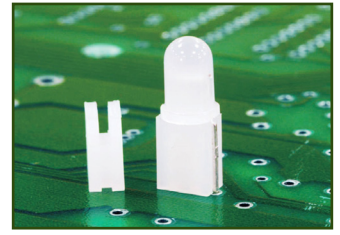
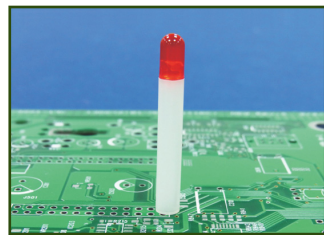
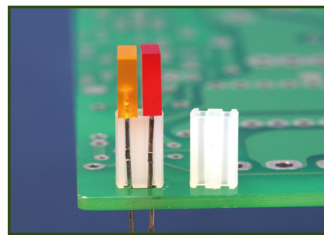
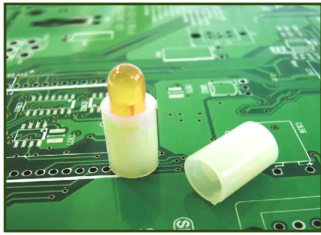
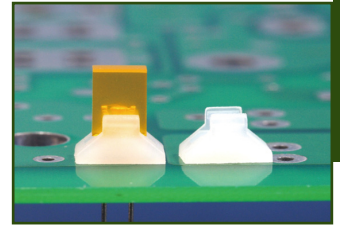
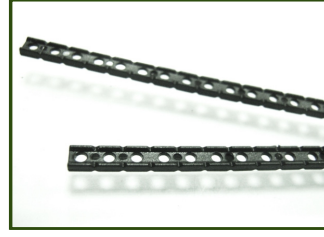
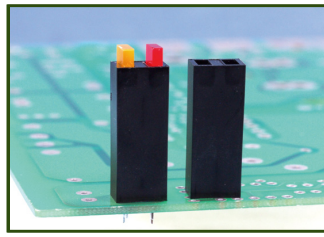

LED间隔柱 / LED隔离柱 / 垫高灯柱 / LED SPACER SUPPORT

LED间隔柱

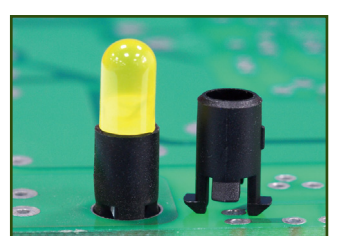
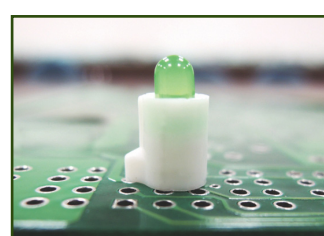
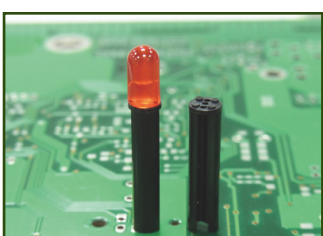
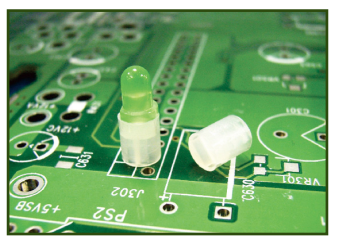
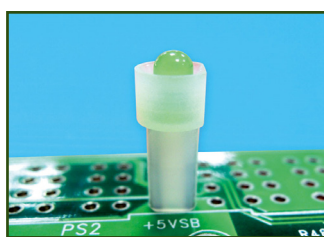
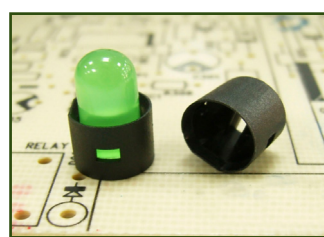
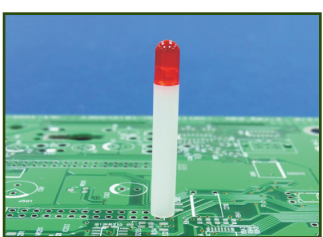
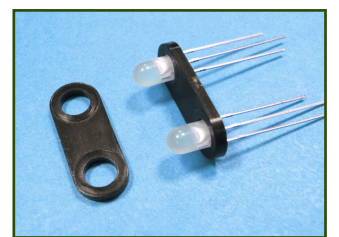
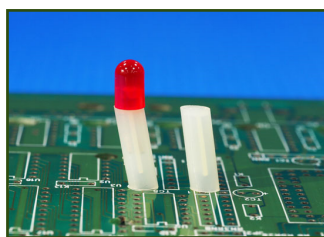
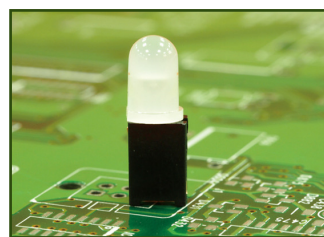
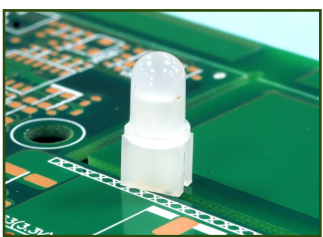
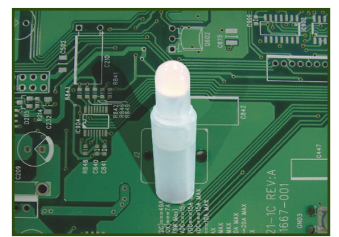
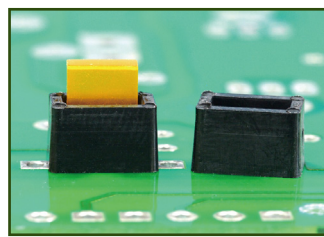
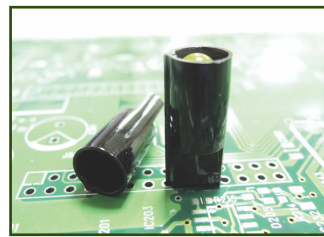
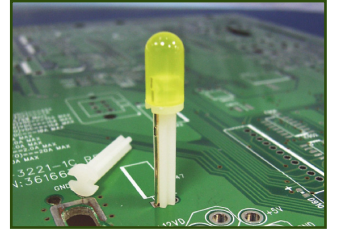
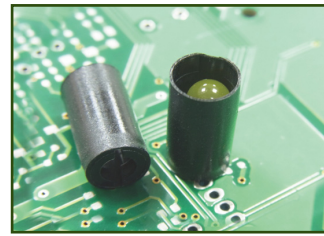
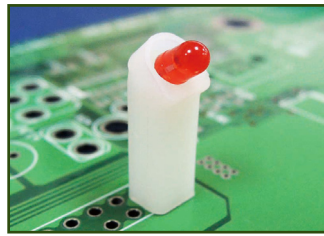
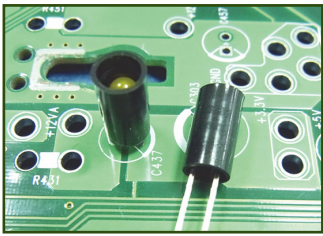
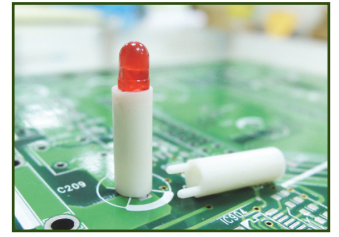
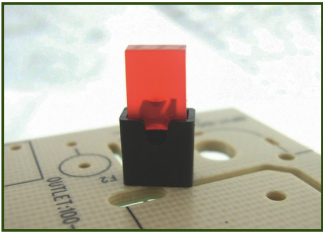
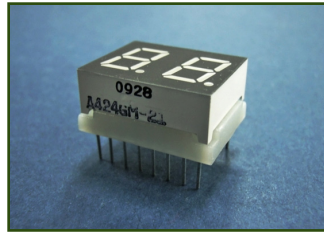
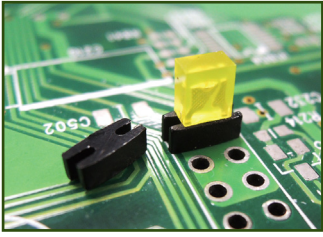

LED间隔柱 /LED隔离柱/垫高灯柱/LED SPACER SUPPORT

LED间隔柱

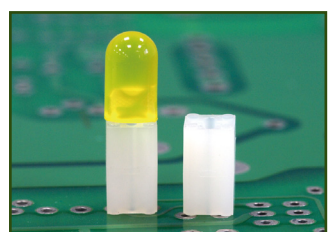
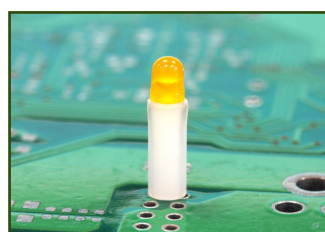
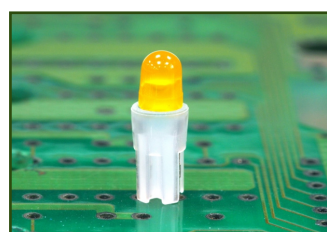
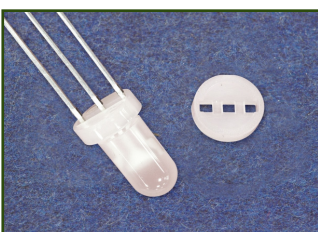
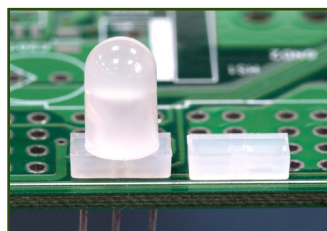
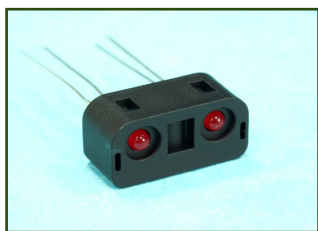
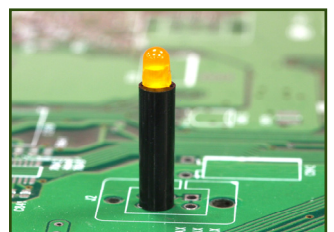
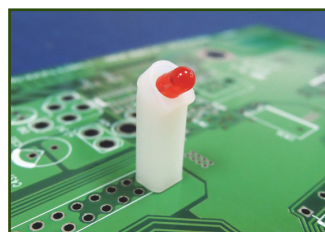
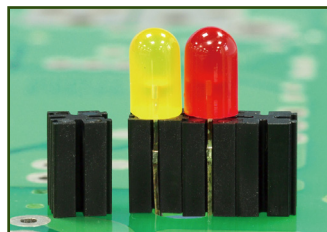
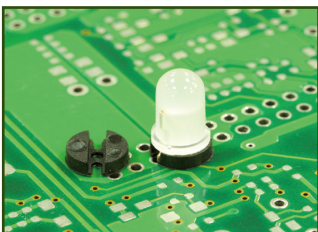
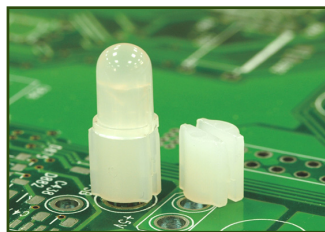
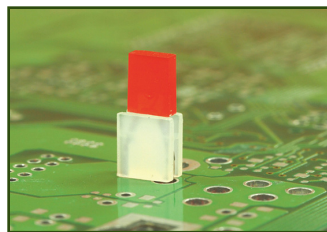
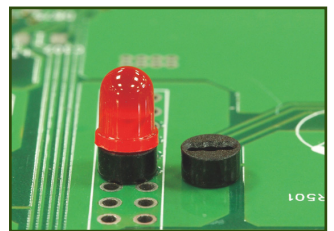
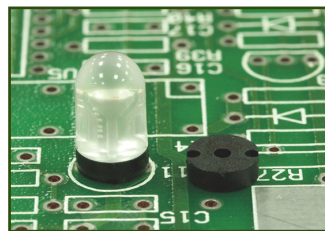
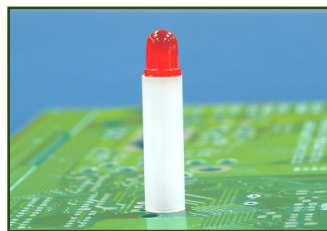
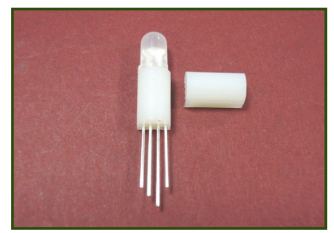
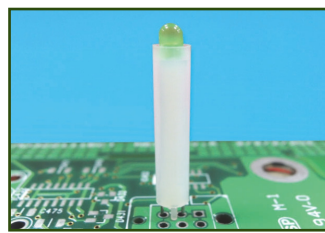
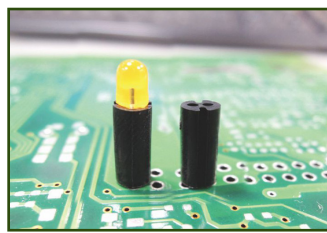
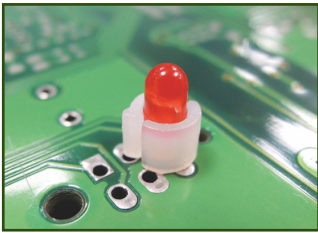
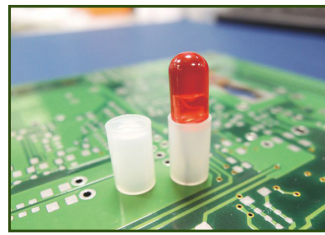
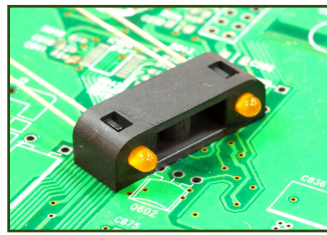
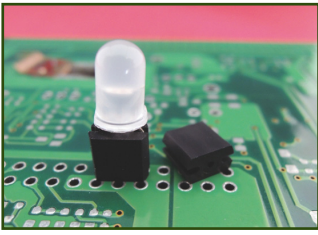

LED间隔柱 /LED隔离柱/垫高灯柱/LED SPACER SUPPORT

LED间隔柱

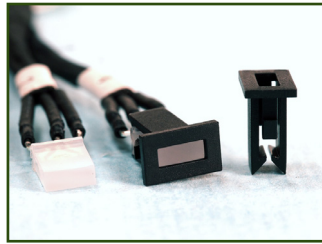
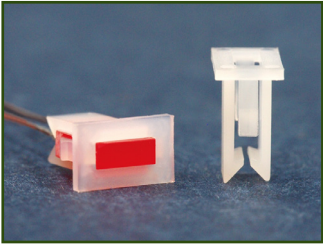
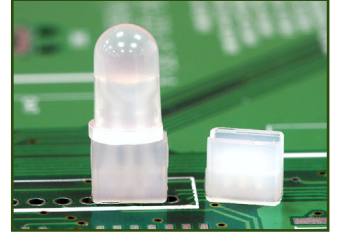
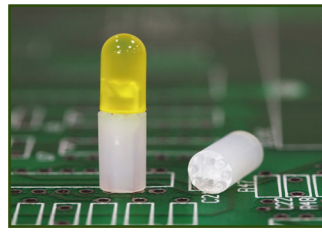
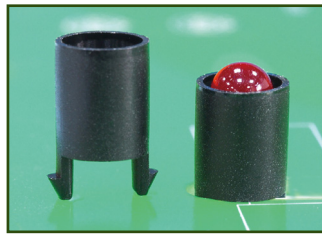
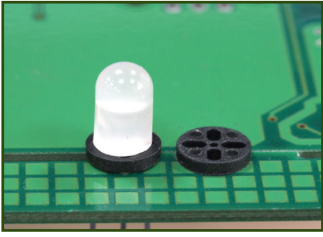

LED间隔柱 LED SPACER SUPPORT



MATERIAL : NYLON 66(UL)
 FLAME CLASS : 94V-0/94V-2
 COLOR : BLACK/NATURAL
 UNIT: mm

用途: LED间隔柱,也称LED隔离柱,垫高灯柱,将LED固定在PC板上,高度一致,不断脚。

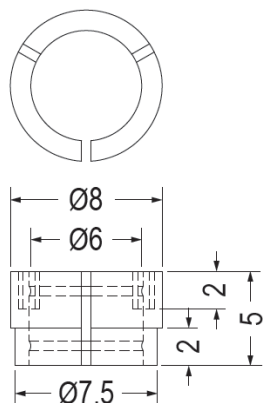

PART NO	PACKAGE
LEDSS-001	2000

LED间隔柱 LED SPACER SUPPORT

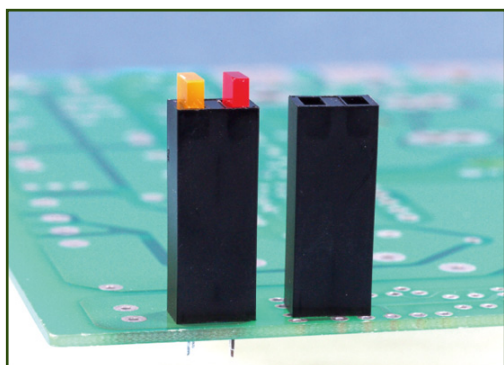

MATERIAL : NYLON 66(UL)
 FLAME CLASS : 94V-0/94V-2
 COLOR : BLACK/NATURAL
 UNIT: mm

用途: LED间隔柱,也称LED隔离柱,垫高灯柱,将LED固定在PC板上,高度一致,不断脚。

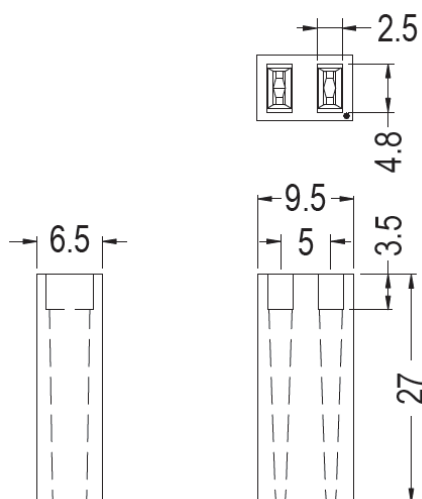

PART NO	P	PACKAGE
LEDSS-002	1	500

(规格 / 尺寸) 代码说明:

P : 装配灯数

LED间隔柱 LED SPACER SUPPORT

LED间隔柱

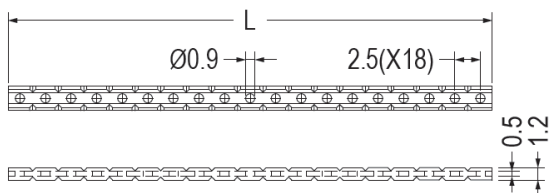
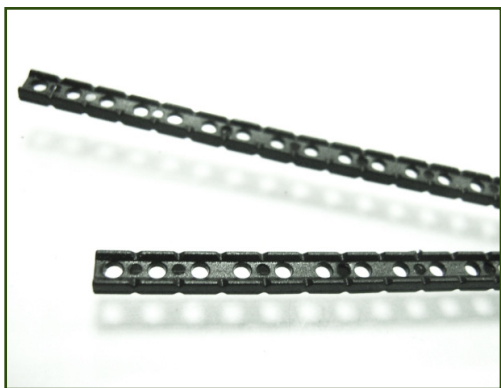

PART NO	L	PACKAGE
LEDSS-463	34.9	500
LEDSS-464	37.4	500
LEDSS-465	39.9	500
LEDSS-466	42.4	500

MATERIAL : NYLON 66(UL)
 FLAME CLASS : 94V-0/94V-2
 COLOR : BLACK
 UNIT: mm

用途: LED垫高, 可以固定间隔, 长度可自行裁切

PART NO	L	PACKAGE
LEDSS-003	47.3	500
LEDSS-451	4.9	500
LEDSS-452	7.4	500
LEDSS-453	9.9	500
LEDSS-454	12.4	500
LEDSS-455	14.9	500
LEDSS-456	17.4	500
LEDSS-457	19.9	500
LEDSS-458	22.4	500
LEDSS-459	24.9	500
LEDSS-460	27.4	500
LEDSS-461	29.9	500
LEDSS-462	32.4	500

LED间隔柱 LED SPACER SUPPORT

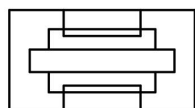
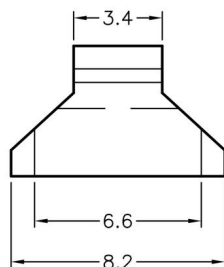
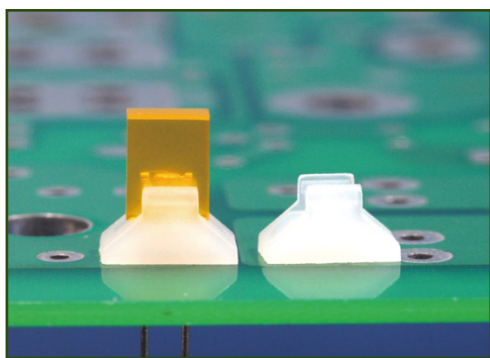

MATERIAL : NYLON 66(UL)
 FLAME CLASS : 94V-0/94V-2
 COLOR : BLACK/NATURAL
 UNIT: mm

用途: 用于保护LED焊于PC板上, 高度一致, 不断脚。

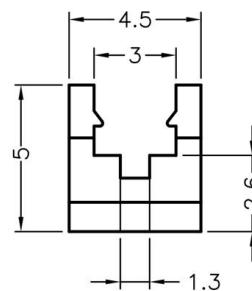

PART NO	PACKAGE
LEDSS-004	2000

LED间隔柱 LED SPACER SUPPORT

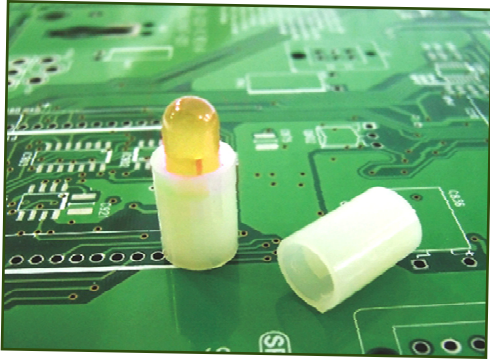

MATERIAL : NYLON 66(UL)
 FLAME CLASS : 94V-0/94V-2
 COLOR : BLACK/NATURAL
 UNIT: mm

用途: 用于保护3PIN Ø5mmLED灯焊在PC板上, 高度一致, 不断脚, 有定位脚, 不歪斜

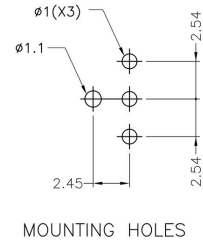
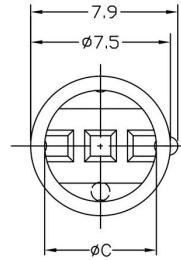
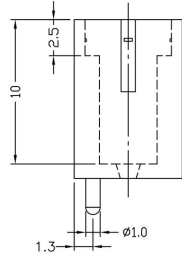
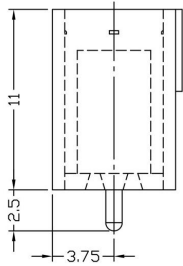

PART NO	C	PACKAGE
LEDSS-005	Ø6.0	1000

LED间隔柱 LED SPACER SUPPORT

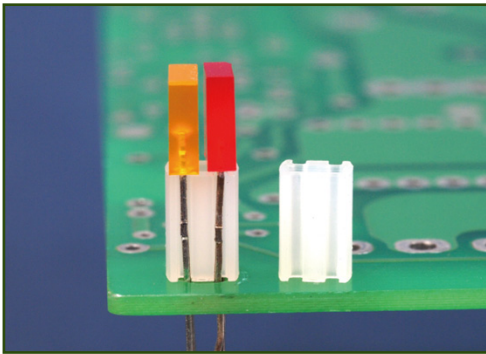

MATERIAL : NYLON 66(UL)
 FLAME CLASS : 94V-0/94V-2
 COLOR : BLACK/NATURAL
 UNIT: mm

用途: 使 LED固定在PCB板上, 高度一致, 不断脚。可用于2个方形LED灯并排

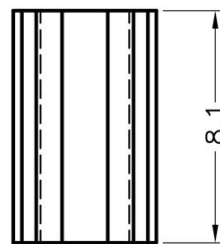
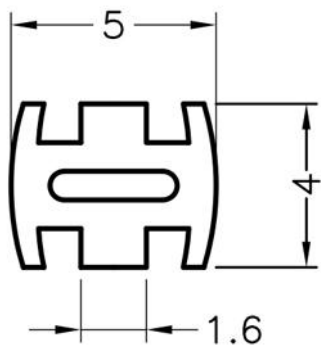

PART NO	PACKAGE
LEDSS-057	2000

LED间隔柱 LED SPACER SUPPORT

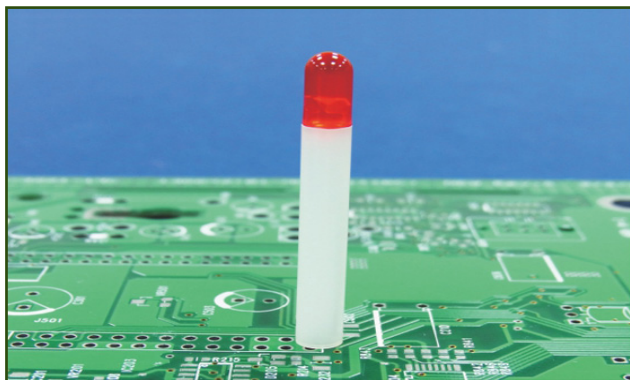

MATERIAL : NYLON 66(UL)
 FLAME CLASS : 94V-0/94V-2
 COLOR : BLACK/NATURAL
 UNIT: mm

用途： 用于保护Ø5mm LED 立在PCB板上，使高度一致，接脚不会弯曲、折断、短路

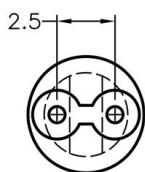
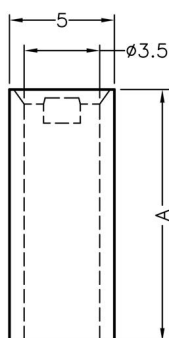

PART NO	A	PACKAGE
LEDSS-006	1.5	2000
LEDSS-007	2.0	2000
LEDSS-008	2.5	2000
LEDSS-009	3.0	2000
LEDSS-010	3.5	2000
LEDSS-011	4.0	2000
LEDSS-012	4.5	2000

PART NO	A	PACKAGE
LEDSS-013	5.0	2000
LEDSS-014	5.5	2000
LEDSS-015	6.0	2000
LEDSS-016	6.5	2000
LEDSS-017	6.8	2000
LEDSS-018	7.0	2000
LEDSS-019	7.5	2000
LEDSS-020	8.0	2000
LEDSS-021	8.5	2000
LEDSS-022	8.8	2000
LEDSS-023	9.0	2000
LEDSS-024	9.5	2000
LEDSS-025	10.0	2000
LEDSS-027	10.5	2000
LEDSS-028	11.0	2000
LEDSS-029	11.5	2000
LEDSS-030	12.0	2000
LEDSS-031	12.5	2000
LEDSS-032	13.0	2000
LEDSS-033	13.5	2000
LEDSS-034	14.0	1000
LEDSS-035	14.5	1000
LEDSS-036	15.0	1000
LEDSS-037	15.5	1000
LEDSS-040	17.0	1000
LEDSS-026	10.0	2000
LEDSS-038	16.0	1000
LEDSS-039	16.5	1000
LEDSS-041	17.5	1000
LEDSS-042	17.7	1000
LEDSS-043	18.0	1000
LEDSS-044	18.5	1000
LEDSS-045	19.0	1000
LEDSS-046	19.5	1000
LEDSS-047	20.0	1000
LEDSS-048	20.5	1000
LEDSS-049	21.0	1000
LEDSS-050	21.5	1000
LEDSS-051	22.0	1000
LEDSS-052	22.5	1000
LEDSS-053	23.0	1000
LEDSS-054	23.5	1000
LEDSS-055	24.0	1000
LEDSS-056	28.0	1000

LED间隔柱 LED SPACER SUPPORT

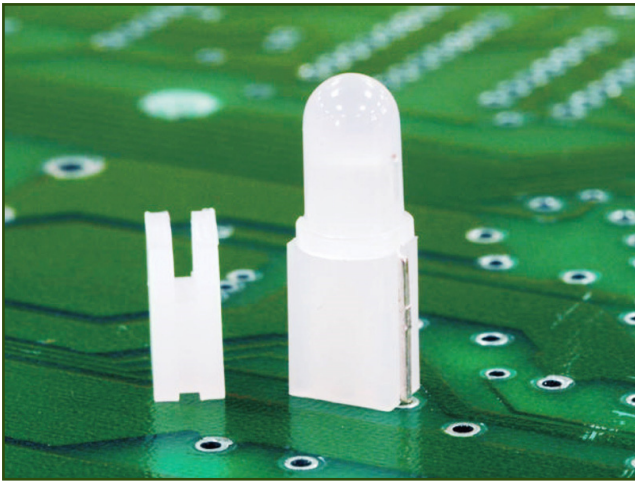

MATERIAL : NYLON 66(UL)
 FLAME CLASS : 94V-0/94V-2
 COLOR : BLACK/NATURAL
 UNIT: mm

用途： 保护双色LED灯3PIN固定在PCB板上，使LED灯接脚不会弯曲、折断、短路，并使LED灯高度一致。

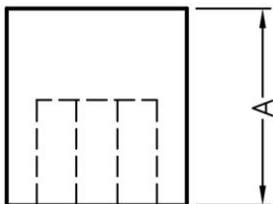
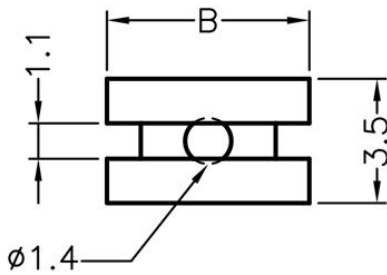

PART NO	A	B	PACKAGE
LEDSS-059	3.0	5.7	2000
LEDSS-060	3.5	5.7	2000
LEDSS-061	4.0	5.7	2000
LEDSS-062	4.5	5.7	2000
LEDSS-063	5.0	5.7	2000
LEDSS-064	5.5	5.7	2000
LEDSS-065	6.0	5.7	2000
LEDSS-092	6.5	5.7	2000
LEDSS-066	7.0	5.7	2000
LEDSS-067	7.5	5.7	2000
LEDSS-068	8.0	5.7	2000
LEDSS-069	8.5	5.7	2000
LEDSS-070	9.0	5.7	1000
LEDSS-071	9.5	5.7	1000
LEDSS-072	10.0	5.7	1000
LEDSS-073	10.5	5.7	1000
LEDSS-074	11.0	6.0	1000
LEDSS-075	11.5	5.7	1000
LEDSS-076	12.0	5.7	1000
LEDSS-077	12.5	5.7	1000
LEDSS-078	13.0	5.7	1000
LEDSS-079	13.6	5.7	1000
LEDSS-080	14.0	5.7	1000
LEDSS-081	14.5	5.7	1000
LEDSS-082	15.0	7.0	1000
LEDSS-083	15.5	5.7	1000
LEDSS-084	16.0	5.7	1000
LEDSS-085	16.5	5.7	1000
LEDSS-086	17.0	5.7	1000
LEDSS-087	17.5	5.7	1000
LEDSS-088	18.0	5.7	1000
LEDSS-089	18.5	5.7	1000
LEDSS-090	19.0	5.7	1000
LEDSS-091	19.5	5.7	1000
LEDSS-400	22.0	5.7	1000

LED间隔柱 LED SPACER SUPPORT

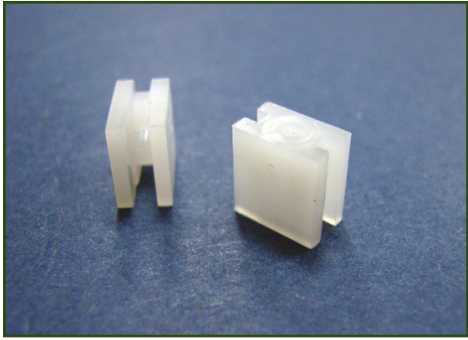

MATERIAL : NYLON 66(UL)
 FLAME CLASS : 94V-0/94V-2
 COLOR : BLACK/NATURAL
 UNIT: mm

用途: 保护双色LED灯3PIN固定在PCB板上, 使LED灯接

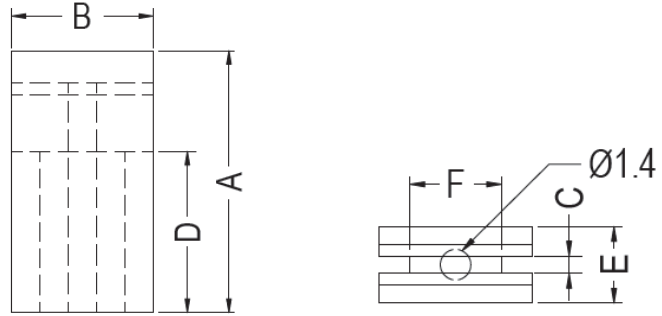

PART NO	A	B	C	D	E	F	PACKAGE
LEDSS-093	13.0	7.0	0.8	8.0	3.5	4.2	1000
LEDSS-094	16.0	6.0	0.9	11.5	3.9	4.3	1000

LED间隔柱 LED SPACER SUPPORT

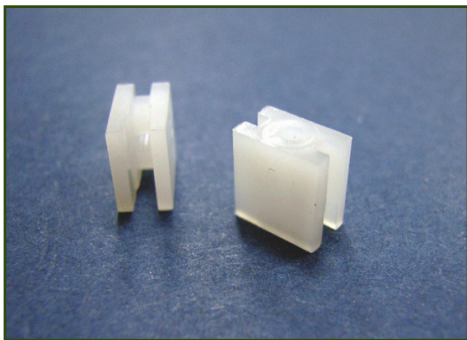

MATERIAL : NYLON 66(UL)
 FLAME CLASS : 94V-0/94V-2
 COLOR : BLACK/NATURAL
 UNIT: mm

用途: 保护双色LED灯3PIN固定在PCB板上, 使LED灯接脚不会弯曲、折断、短路, 并使LED灯高度一致。

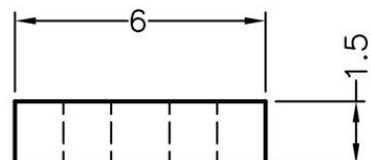
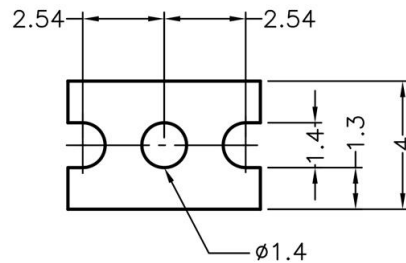

PART NO	PACKAGE
LEDSS-095	2000

LED间隔柱 LED SPACER SUPPORT

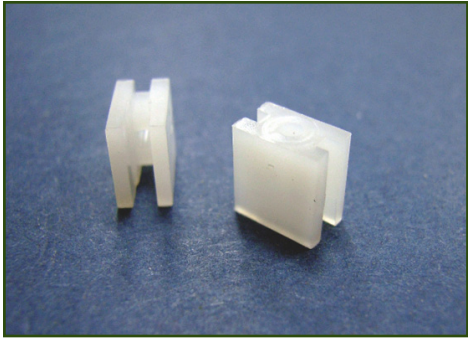

MATERIAL : NYLON 66(UL)
 FLAME CLASS : 94V-0/94V-2
 COLOR : BLACK/NATURAL
 UNIT: mm

用途：保护双色LED灯3PIN固定在PCB板上，使LED灯接脚不会弯曲、折断、短路，并使LED灯高度一致。

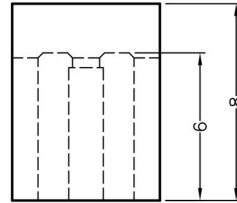
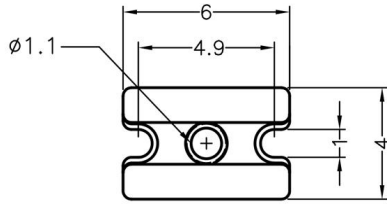

PART NO	PACKAGE
LEDSS-096	2000

LED间隔柱 LED SPACER SUPPORT

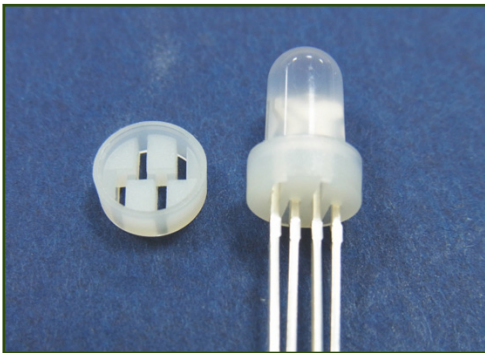

MATERIAL : NYLON 66(UL)
 FLAME CLASS : 94V-0/94V-2
 COLOR : BLACK/NATURAL
 UNIT: mm

用途：使4PIN变色LED灯固定在PCB板上，高度一致，不断脚,建议用 $\phi 5\text{mm}$ LED灯。

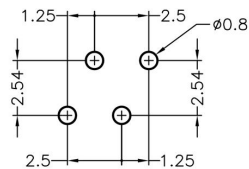
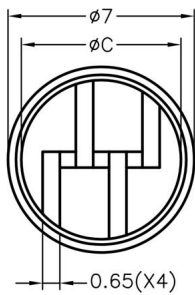

RECOMMEND MOUNTING HOLE

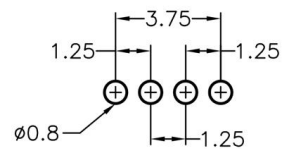

RECOMMEND MOUNTING HOLE

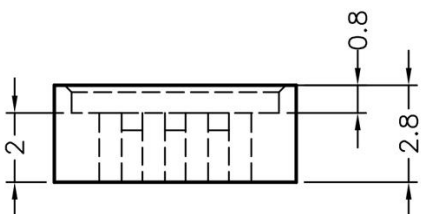

PART NO	C	PACKAGE
LEDSS-097	$\phi 6.0$	2000

LED间隔柱 LED SPACER SUPPORT

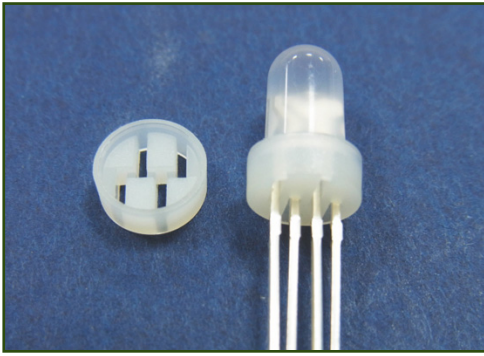

MATERIAL : NYLON 66(UL)
 FLAME CLASS : 94V-0/94V-2
 COLOR : BLACK/NATURAL
 UNIT: mm

用途：使4PIN变色LED灯固定在PCB板上，高度一致，不断脚,建议用Ø5mmLED灯。

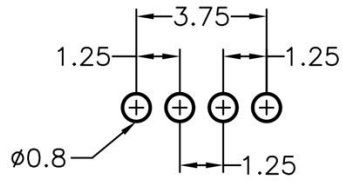
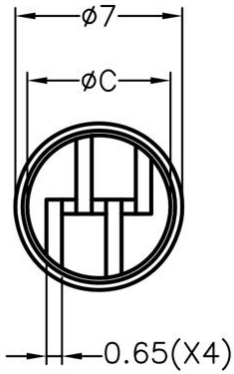

RECOMMEND MOUNTING HOLE

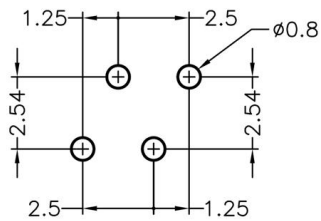
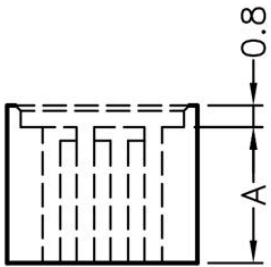

RECOMMEND MOUNTING HOLE

PART NO	A	C	PACKAGE
LEDSS-098	2.5	Ø6.0	1000
LEDSS-099	3.0	Ø6.0	1000
LEDSS-100	3.5	Ø6.0	1000
LEDSS-101	4.0	Ø6.0	1000
LEDSS-102	4.5	Ø6.0	1000
LEDSS-103	5.0	Ø6.0	1000
LEDSS-104	5.5	Ø6.0	1000
LEDSS-105	6.0	Ø6.0	1000
LEDSS-106	6.5	Ø6.0	1000
LEDSS-107	7.0	Ø6.0	1000
LEDSS-108	7.5	Ø6.0	1000
LEDSS-109	8.0	Ø6.0	1000
LEDSS-110	8.5	Ø6.0	1000
LEDSS-111	9.0	Ø6.0	1000
LEDSS-112	9.5	Ø6.0	1000
LEDSS-113	10.0	Ø6.0	1000

LED间隔柱 LED SPACER SUPPORT

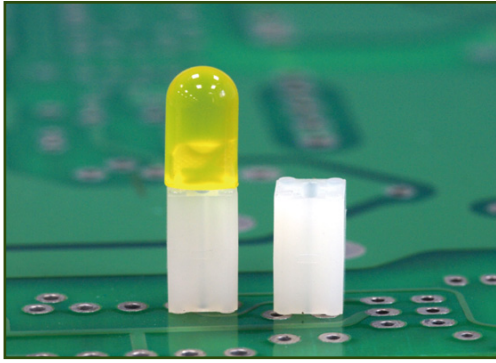

MATERIAL : NYLON 66(UL)
 FLAME CLASS : 94V-0/94V-2
 COLOR : BLACK/NATURAL
 UNIT: mm

用途：使LED灯固定在PCB板上，高度一致，不断脚。

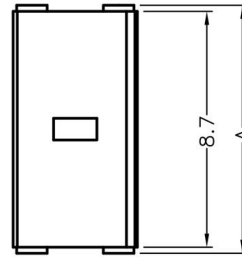
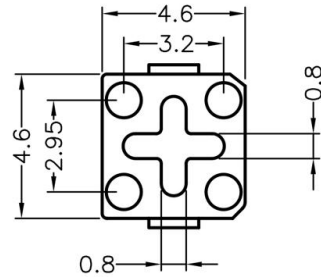

PART NO	A	PACKAGE
LEDSS-114	9.15	1000
LEDSS-115	10.15	1000

LED间隔柱 LED SPACER SUPPORT

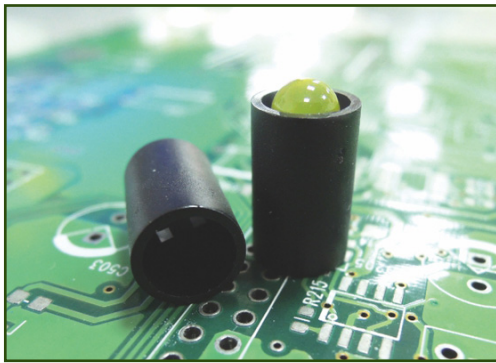

MATERIAL : NYLON 66(UL)
 FLAME CLASS : 94V-0/94V-2
 COLOR : BLACK/NATURAL
 UNIT: mm

用途：使 $\varnothing 5$ mm的LED灯站立在PCB板上，高度一致，不断脚

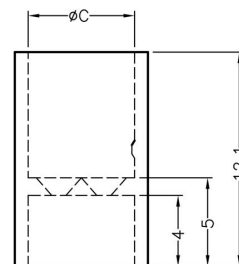
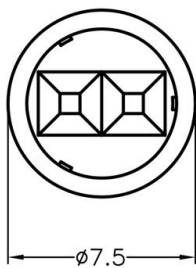

PART NO	C	PACKAGE
LEDSS-116	$\varnothing 6$	1000

LED间隔柱 LED SPACER SUPPORT

LED间隔柱

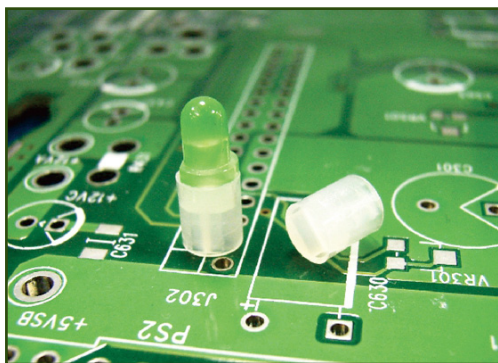

MATERIAL : NYLON 66(UL)
 FLAME CLASS : 94V-0/94V-2
 COLOR : BLACK/NATURAL
 UNIT: mm

用途: 用于保护 $\varnothing 3\text{mm}$ LED灯固定在PCB板上, 使LED灯高度一致, 中间隔板设计, 保护LED灯接脚不会弯曲、折断、短路。

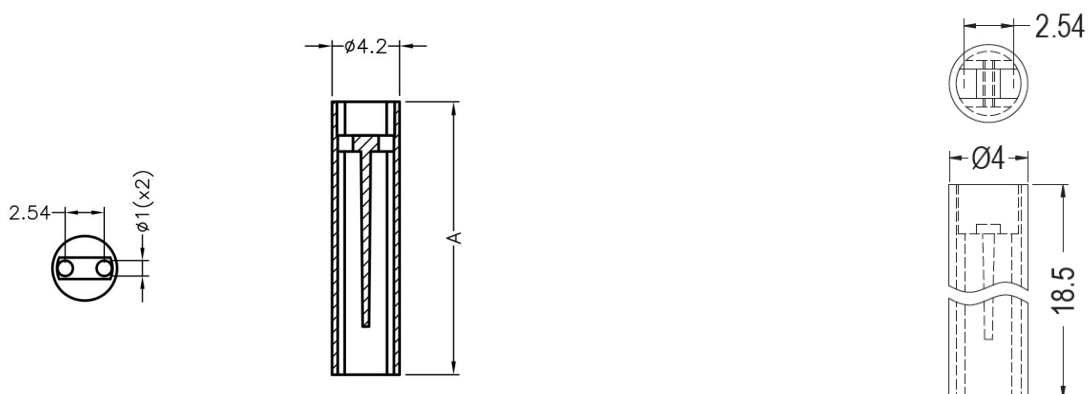

PART NO	A	PACKAGE
LEDSS-117	5.0	1000
LEDSS-118	8.5	1000
LEDSS-119	15.0	1000
LEDSS-120	17.0	1000
LEDSS-121	17.5	1000

PART NO	PACKAGE
LEDSS-339	1000

LED间隔柱 LED SPACER SUPPORT

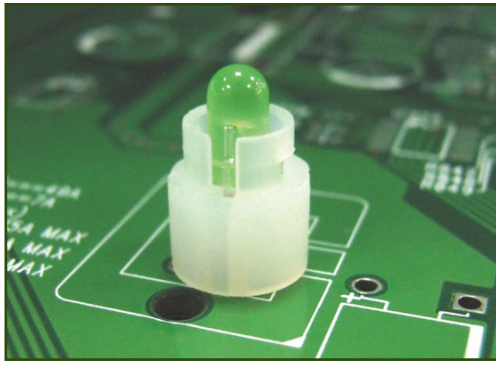

MATERIAL : NYLON 66(UL)
 FLAME CLASS : 94V-0/94V-2
 COLOR : BLACK/NATURAL
 UNIT: mm

用途: 将LED灯柱固定在PCB板上, 高度一致, 不断脚。

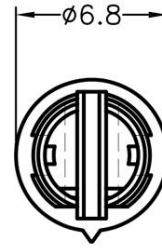
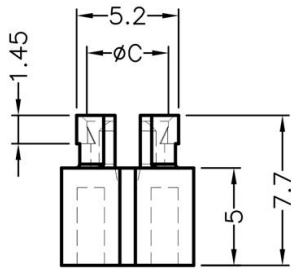

PART NO	C	L	P	PACKAGE
LEDSS-124	$\phi 4.2$	3.0	1	2000

(规格 / 尺寸) 代码说明:

L: LED建议装配柜台 P: 装配灯数

LED间隔柱 LED SPACER SUPPORT

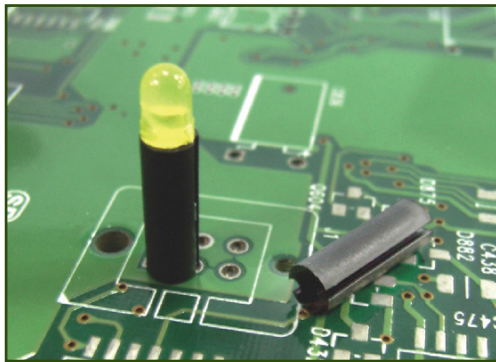

MATERIAL : NYLON 66(UL)
 FLAME CLASS : 94V-0/94V-2
 COLOR : BLACK/NATURAL
 UNIT: mm

用途: 将 $\phi 3\text{mm}$ 的LED灯柱固定在PCB板上, 使LED灯柱高度一致, 不断脚。

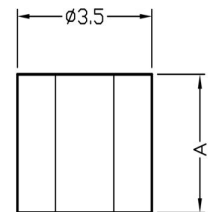
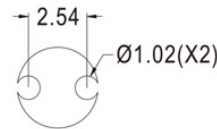
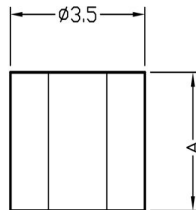
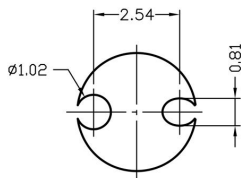

(规格 / 尺寸) 代码说明:

L: LED建议装配柜台 P: 装配灯数

PART NO	A	L	P	PACKAGE
LEDSS-125	3.0	3.0	1	2000
LEDSS-127	10.1	3.0	1	2000

PART NO	A	L	P	PACKAGE
LEDSS-126	4.0	3.0	1	2000

LED间隔柱 LED SPACER SUPPORT



MATERIAL : NYLON 66(UL)
 FLAME CLASS : 94V-0/94V-2
 COLOR : BLACK/NATURAL
 UNIT: mm

用途: 将LED灯柱固定在PCB板上, 使LED灯柱高度一致, 不断脚。

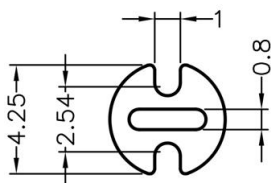
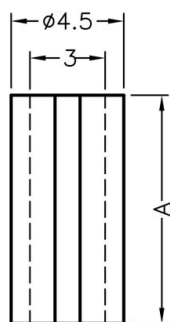

(规格 / 尺寸) 代码说明:

L: LED建议装配规格

P: 装配灯数

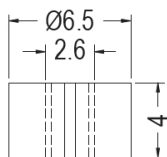
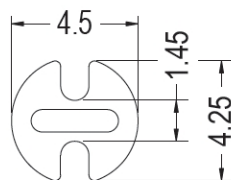

PART NO	A	L	P	PACKAGE
LEDSS-128	1.5	3.0	1	2000
LEDSS-129	2.0	3.0	1	2000
LEDSS-130	2.5	3.0	1	2000
LEDSS-131	3.0	3.0	1	2000
LEDSS-132	3.5	3.0	1	2000
LEDSS-133	4.0	3.0	1	2000
LEDSS-134	4.5	3.0	1	2000
LEDSS-135	5.0	3.0	1	2000
LEDSS-136	5.5	3.0	1	2000
LEDSS-137	6.0	3.0	1	2000
LEDSS-138	6.5	3.0	1	2000
LEDSS-139	7.0	3.0	1	2000
LEDSS-140	7.5	3.0	1	2000
LEDSS-141	8.0	3.0	1	2000
LEDSS-142	8.5	3.0	1	2000
LEDSS-143	9.0	3.0	1	2000
LEDSS-144	9.5	3.0	1	2000
LEDSS-145	10.0	3.0	1	2000
LEDSS-146	10.5	3.0	1	2000
LEDSS-147	11.0	3.0	1	2000
LEDSS-148	11.5	3.0	1	2000
LEDSS-149	12.0	3.0	1	2000
LEDSS-150	12.5	3.0	1	2000
LEDSS-151	13.0	3.0	1	2000
LEDSS-152	13.5	3.0	1	2000
LEDSS-153	14.0	3.0	1	2000
LEDSS-154	14.5	3.0	1	2000
LEDSS-155	15.0	3.0	1	2000
LEDSS-156	15.5	3.0	1	2000
LEDSS-382	17.0	3.0	1	2000
LEDSS-157	18.0	3.0	1	1000
LEDSS-383	1.0	3.0	1	2000
LEDSS-384	16.0	3.0	1	2000
LEDSS-473	17.5	3.0	1	1000

PART NO	PACKAGE
LEDSS-467	2000

PART NO	PACKAGE
LEDSS-449	2000

LED间隔柱 LED SPACER SUPPORT

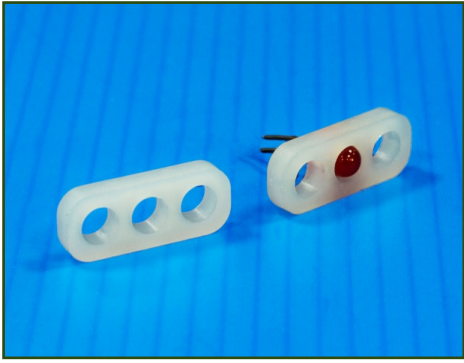

MATERIAL : NYLON 66(UL)
 FLAME CLASS : 94V-0/94V-2
 COLOR : BLACK/NATURAL
 UNIT: mm

用途: 可配合LED定位。

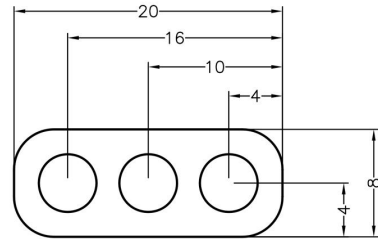
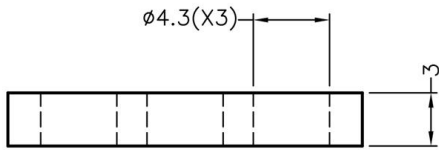

PART NO	P	PACKAGE
LEDSS-158	3	1000

(规格 / 尺寸) 代码说明:

P : 装配灯数

LED间隔柱 LED SPACER SUPPORT

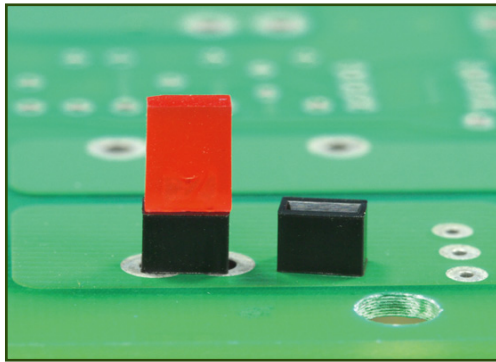

MATERIAL : NYLON 66(UL)
 FLAME CLASS : 94V-0/94V-2
 COLOR : BLACK/NATURAL
 UNIT: mm

用途: 将LED灯柱固定在PCB板上, 使LED灯柱高度一致, 不断脚。

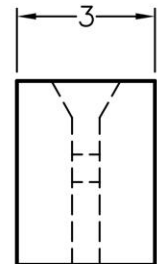
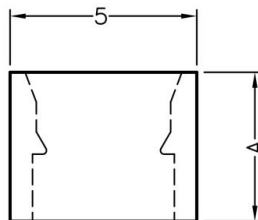
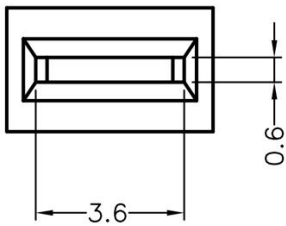

PART NO	A	PACKAGE
LEDSS-159	4.0	2000
LEDSS-160	4.5	2000

LED间隔柱 LED SPACER SUPPORT



MATERIAL : NYLON 66(UL)
 FLAME CLASS : 94V-0/94V-2
 COLOR : BLACK/NATURAL
 UNIT: mm

用途: 使LED固定于PC板上, 高度一致, 不断脚。

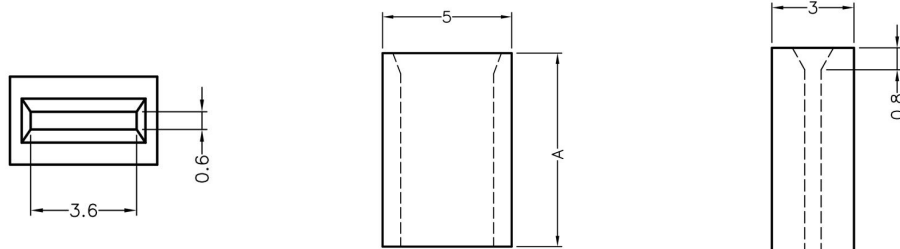

PART NO	A	P	PACKAGE
LEDSS-161	7.5	1	2000
LEDSS-162	8.0	1	2000
LEDSS-163	8.5	1	2000

(规格 / 尺寸) 代码说明:

P : 装配灯数

LED间隔柱 LED SPACER SUPPORT

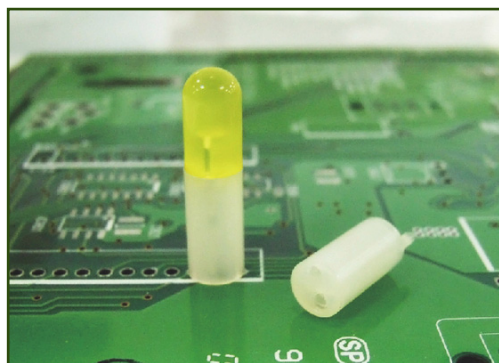

MATERIAL : NYLON 66(UL)
 FLAME CLASS : 94V-0/94V-2
 COLOR : BLACK/NATURAL
 UNIT: mm

用途: 用于保护Ø5mm的LED灯柱立在PCB板上, 使LED灯柱高度一致, 带中间隔板设计, LED灯柱的接脚不会弯曲、折断、短路, 有定位脚, 不歪斜

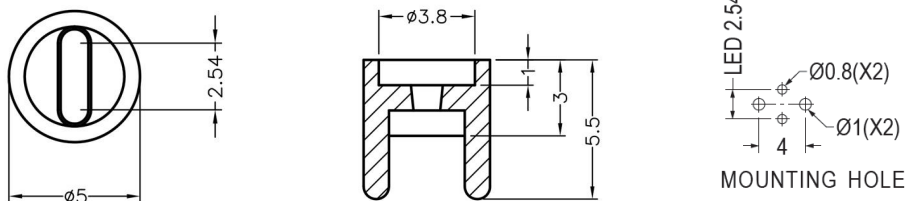

PART NO	L	P	PACKAGE
LEDSS-164	5.0	1	1000

(规格 / 尺寸) 代码说明:

L : LED建议装配规格 P : 装配灯数

LED间隔柱 LED SPACER SUPPORT

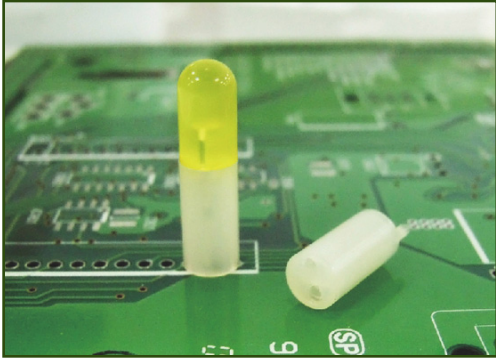

MATERIAL : NYLON 66(UL)
 FLAME CLASS : 94V-0/94V-2
 COLOR : BLACK/NATURAL
 UNIT: mm

用途: 用于保护Ø5mm的LED灯柱立在PCB板上, 使LED灯柱高度一致, 带中间隔板设计, LED灯柱的接脚不会弯曲、折断、短路, 有定位脚, 不歪斜

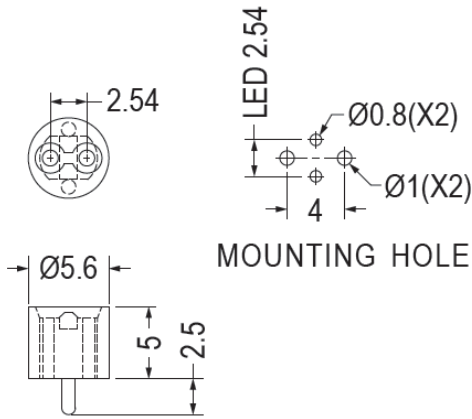

PART NO	PACKAGE
LEDSS-165	1000

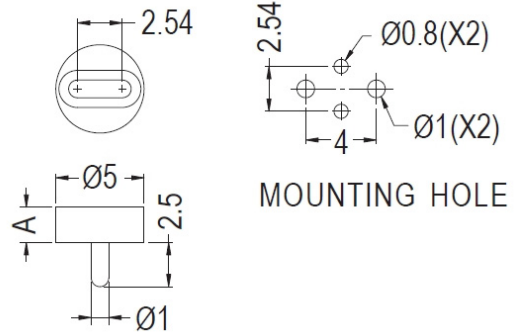

PART NO	A	PACKAGE
LEDSS-166	2.0	2000
LEDSS-167	3.0	2000

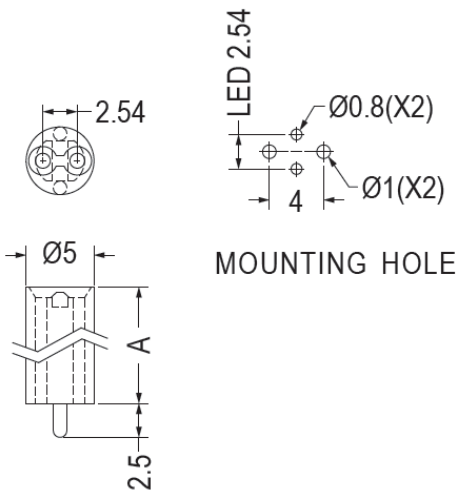

PART NO	A	PACKAGE
LEDSS-168	4.0	2000
LEDSS-169	6.0	2000
LEDSS-170	7.0	2000
LEDSS-171	8.0	2000
LEDSS-172	9.0	2000
LEDSS-173	10.0	2000
LEDSS-174	11.0	1000
LEDSS-175	11.5	1000
LEDSS-176	12.0	1000
LEDSS-177	12.5	1000
LEDSS-178	13.0	1000
LEDSS-179	14.0	1000
LEDSS-180	18.0	1000
LEDSS-387	20.0	1000

LED间隔柱 LED SPACER SUPPORT

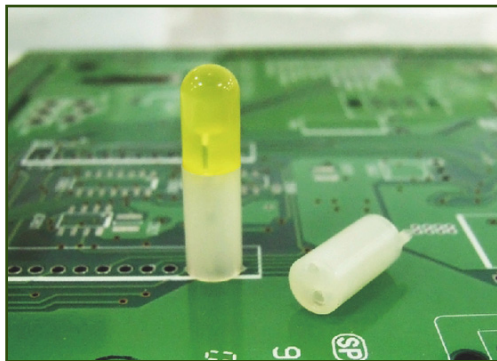

MATERIAL : NYLON 66(UL)
 FLAME CLASS : 94V-0/94V-2
 COLOR : BLACK/NATURAL
 UNIT: mm

用途: 用于保护 $\varnothing 5\text{mm}$ 的LED灯柱立在PCB板上, 使LED灯柱高度一致, 带中间隔板设计, LED灯柱的接脚不会弯曲、折断、短路, 有定位脚, 不歪斜

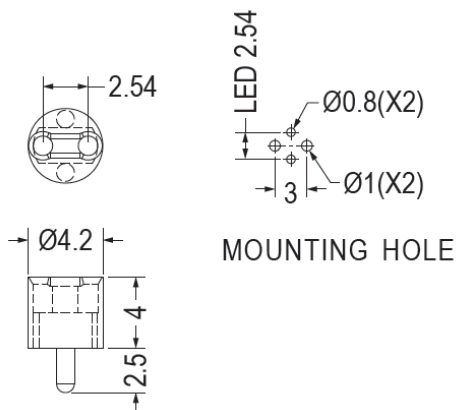

(规格 / 尺寸) 代码说明:

L: LED建议装配规格 P: 装配灯数

PART NO	L	P	PACKAGE
LEDSS-181	5.0	1	1000

LED间隔柱 LED SPACER SUPPORT



MATERIAL : NYLON 66(UL)
 FLAME CLASS : 94V-0/94V-2
 COLOR : BLACK/NATURAL
 UNIT: mm

用途: 把 $\varnothing 3\text{mm}$ LED灯柱立在PC板上, 高度一致, 不断脚。

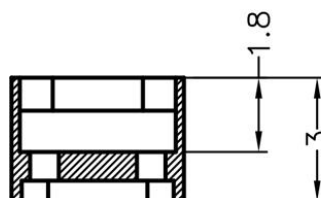
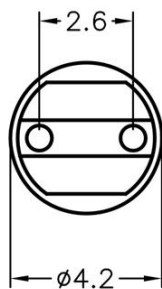

PART NO	L	P	PACKAGE
LEDSS-182	3.0	1	2000

(规格 / 尺寸) 代码说明:

L: LED建议装配规格 P: 装配灯数

LED间隔柱 LED SPACER SUPPORT

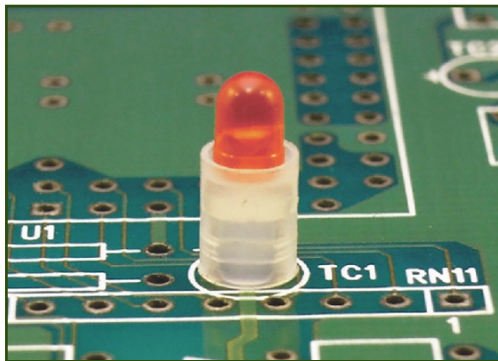

MATERIAL : NYLON 66(UL)
 FLAME CLASS : 94V-0/94V-2
 COLOR : BLACK/NATURAL
 UNIT: mm

用途: 把 $\varnothing 3\text{mm}$ 的LED灯柱立于PC板上, 高度一致, 不断脚。

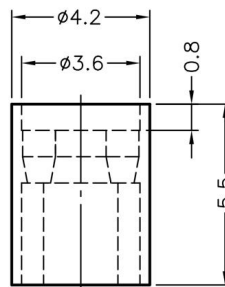
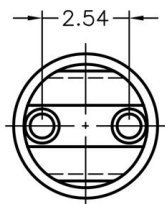

PART NO	L	P	PACKAGE
LEDSS-183	3.0	1	2000

(规格 / 尺寸) 代码说明:

L: LED建议装配规格 P: 装配灯数

LED间隔柱 LED SPACER SUPPORT

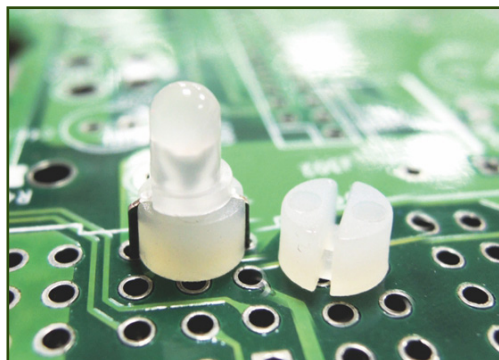

MATERIAL : NYLON 66(UL)
 FLAME CLASS : 94V-0/94V-2
 COLOR : BLACK/NATURAL
 UNIT: mm

用途: 把3PIN $\varnothing 3\text{mm}$ 的LED灯柱固定于PC板上, 使LED灯柱高度一致, 不断脚。

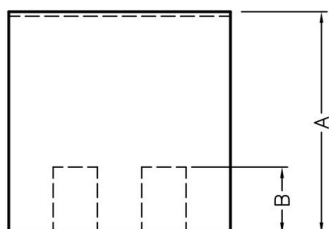
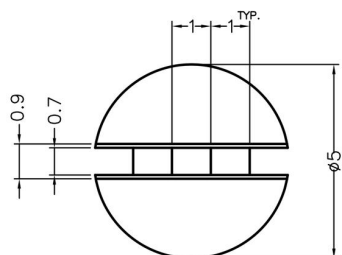

PART NO	A	B	PACKAGE
LEDSS-184	4.0	1.0	2000
LEDSS-185	3.0	1.0	2000
LEDSS-186	5.0	1.5	2000
LEDSS-187	16.0	13.0	1000
LEDSS-434	8.0	5.0	2000

LED间隔柱 LED SPACER SUPPORT

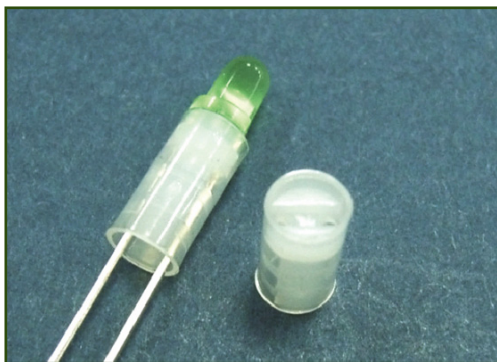

MATERIAL : NYLON 66(UL)
 FLAME CLASS : 94V-0/94V-2
 COLOR : BLACK/NATURAL
 UNIT: mm

用途: 用于保护 $\varnothing 3\text{mm}$ 的LED灯柱立于PC板上, 使LED灯柱高度一致, 接脚不会、弯曲、折断、短路。

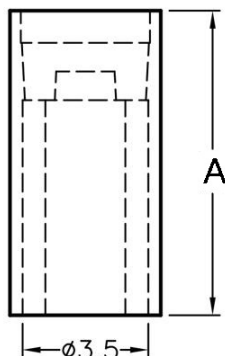
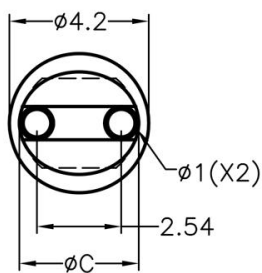

PART NO	A	C	PACKAGE
LEDSS-188	8.5	$\varnothing 3.6$	1000
LEDSS-189	10.0	$\varnothing 3.6$	1000
LEDSS-190	15.0	$\varnothing 3.6$	1000
LEDSS-191	20.0	$\varnothing 3.6$	1000

LED间隔柱 LED SPACER SUPPORT

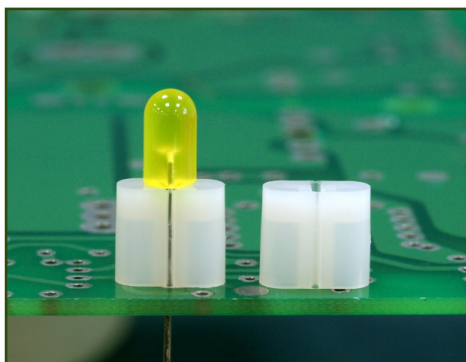

MATERIAL : NYLON 66(UL)
 FLAME CLASS : 94V-0/94V-2
 COLOR : BLACK/NATURAL
 UNIT: mm

用途: 配合LED使用

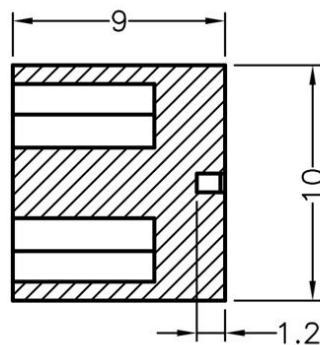
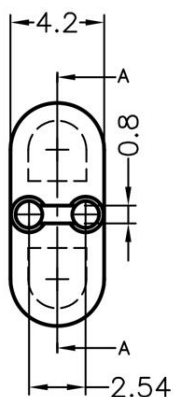

SECTION A-A

PART NO	PACKAGE
LEDSS-192	1000

LED间隔柱 LED SPACER SUPPORT

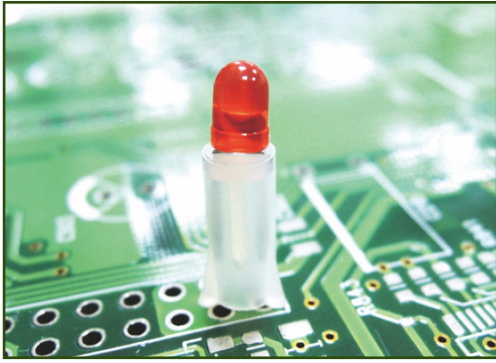

MATERIAL : NYLON 66(UL)
 FLAME CLASS : 94V-0/94V-2
 COLOR : BLACK/NATURAL
 UNIT: mm

用途: 把LED灯柱立于PC板上, 使LED灯柱高度一致, 不断脚。

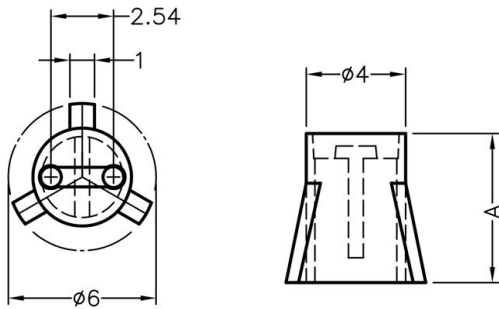

(规格 / 尺寸) 代码说明:

L: LED建议装配规格 P: 装配灯数

PART NO	A	L	P	PACKAGE
LEDSS-193	6.0	3.0	1	2000
LEDSS-194	9.5	3.0	1	2000
LEDSS-195	15.5	3.0	1	1000

LED间隔柱 LED SPACER SUPPORT

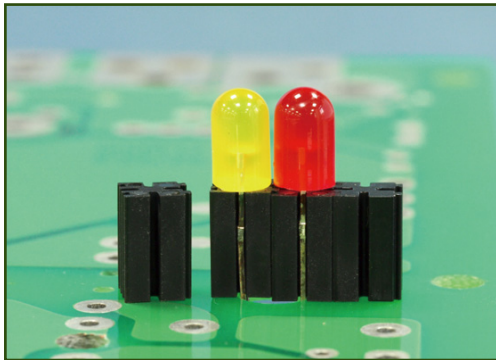

MATERIAL : NYLON 66(UL)
 FLAME CLASS : 94V-0/94V-2
 COLOR : BLACK/NATURAL
 UNIT: mm

用途: 保护LED固定PC板上,使接脚不会弯曲、折断、短路, 可连接多个LED座, 并使LED高度一致。

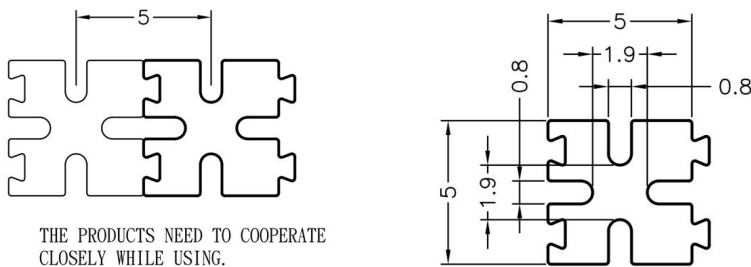

THE PRODUCTS NEED TO COOPERATE CLOSELY WHILE USING.

產品使用時需組合使用

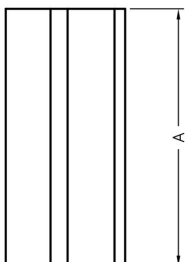

PART NO	A	PACKAGE
LEDSS-196	3.0	2000
LEDSS-197	4.0	2000
LEDSS-198	5.0	2000
LEDSS-199	6.0	2000
LEDSS-200	7.0	2000

PART NO	A	PACKAGE
LEDSS-201	8.0	2000
LEDSS-202	9.0	2000
LEDSS-420	9.5	2000
LEDSS-203	10.0	2000
LEDSS-204	11.0	2000
LEDSS-205	12.0	2000
LEDSS-206	13.0	2000
LEDSS-207	14.0	2000
LEDSS-208	15.0	2000
LEDSS-209	16.0	2000
LEDSS-210	17.0	2000
LEDSS-211	18.0	2000
LEDSS-212	19.0	2000
LEDSS-213	20.0	2000

LED间隔柱 LED SPACER SUPPORT

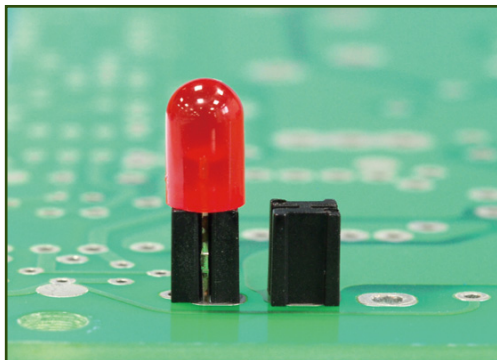

MATERIAL : NYLON 66(UL)
 FLAME CLASS : 94V-0/94V-2
 COLOR : BLACK/NATURAL
 UNIT: mm

用途: 使LED灯柱固定在PCB板上, 高度一致, 不断脚。

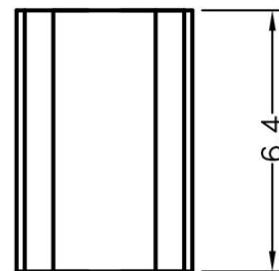
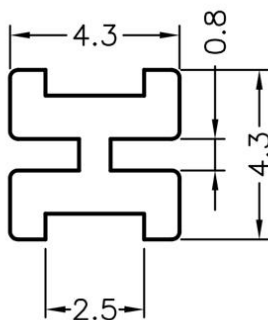

PART NO	PACKAGE
LEDSS-214	500

LED间隔柱 LED SPACER SUPPORT

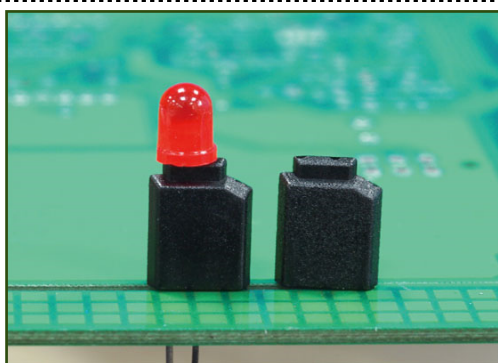

MATERIAL : NYLON 66(UL)
 FLAME CLASS : 94V-0/94V-2
 COLOR : BLACK/NATURAL
 UNIT: mm

用途: 固定LED灯柱焊于PCB板上, 高度一致, 有定位脚, 不倾斜。

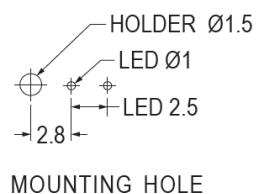
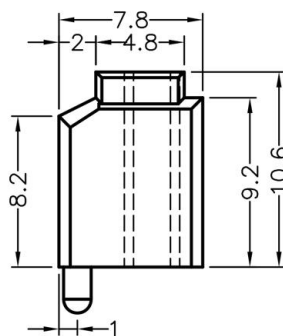
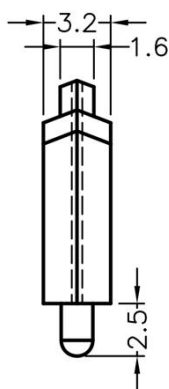

PART NO	PACKAGE
LEDSS-215	1000

LED间隔柱 LED SPACER SUPPORT

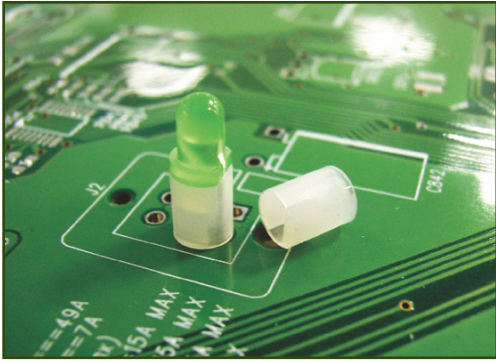

MATERIAL : NYLON 66(UL)
 FLAME CLASS : 94V-0/94V-2
 COLOR : BLACK/NATURAL
 UNIT: mm

用途: 用于保护 $\varnothing 3\text{mm}$ 的LED灯柱立于PC板上, 使LED灯柱的接脚不会弯曲、折断、短路, 且使LED灯柱高度一致, 免用工具, 尺寸齐全

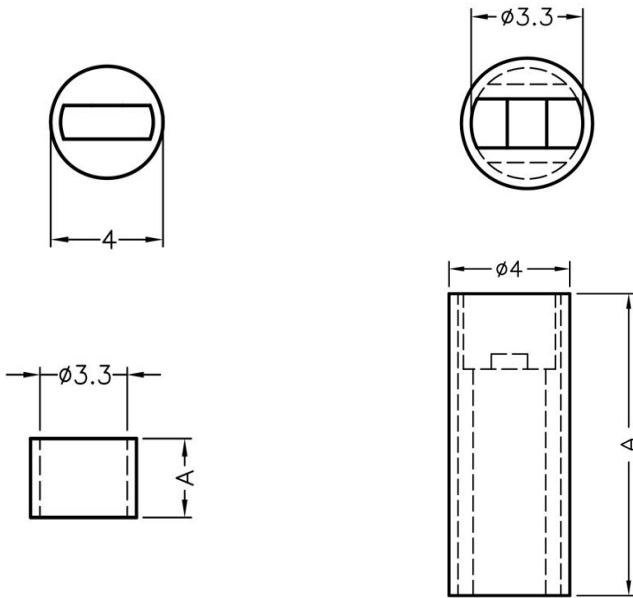

LEDSS-216~222

PART NO	A	PACKAGE
LEDSS-216	0.8	2000
LEDSS-217	1.0	2000
LEDSS-218	1.5	2000
LEDSS-219	2.0	2000
LEDSS-220	2.5	2000
LEDSS-221	3.0	2000
LEDSS-222	3.5	2000

PART NO	A	PACKAGE
LEDSS-223	4.0	2000
LEDSS-224	4.5	2000
LEDSS-225	5.0	1000
LEDSS-226	5.5	2000
LEDSS-227	6.0	2000
LEDSS-228	6.5	2000
LEDSS-229	7.0	2000
LEDSS-230	7.5	2000
LEDSS-231	8.0	2000
LEDSS-232	8.5	2000
LEDSS-233	9.0	2000
LEDSS-234	9.5	2000
LEDSS-340	9.8	2000
LEDSS-235	10.0	2000
LEDSS-236	10.5	2000
LEDSS-237	11.0	2000
LEDSS-238	11.5	2000
LEDSS-239	12.0	2000
LEDSS-240	12.5	2000
LEDSS-241	13.0	2000
LEDSS-242	13.5	2000
LEDSS-243	14.0	2000
LEDSS-244	14.5	2000
LEDSS-245	15.0	2000
LEDSS-246	15.5	2000
LEDSS-247	16.0	2000
LEDSS-248	16.5	1000
LEDSS-249	17.0	1000
LEDSS-250	17.5	1000
LEDSS-251	18.0	1000
LEDSS-252	18.5	1000
LEDSS-253	19.0	1000
LEDSS-254	19.5	1000
LEDSS-255	20.0	1000
LEDSS-256	20.5	1000
LEDSS-257	21.0	1000
LEDSS-258	21.5	1000
LEDSS-259	22.0	1000
LEDSS-260	22.5	1000
LEDSS-261	23.0	1000
LEDSS-262	23.5	1000
LEDSS-263	24.0	1000

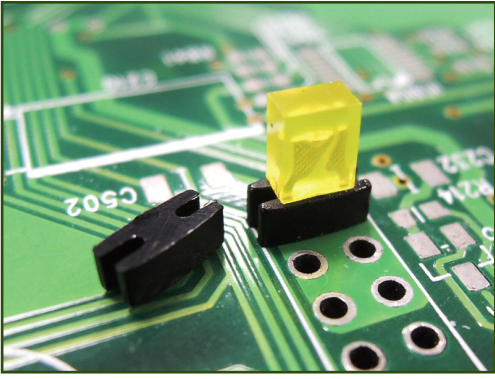

MATERIAL : NYLON 66(UL)
 FLAME CLASS : 94V-0/94V-2
 COLOR : BLACK/NATURAL
 UNIT: mm

用途：使LED灯柱立在PCB板上，高度一致，不断脚

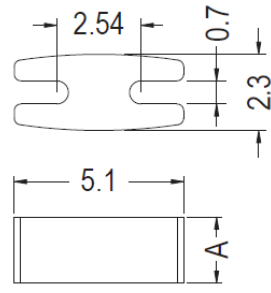

PART NO	A	PACKAGE
LEDSS-264	2.0	2000
LEDSS-435	3.5	2000
LEDSS-446	6.0	2000

LED间隔柱 LED SPACER SUPPORT

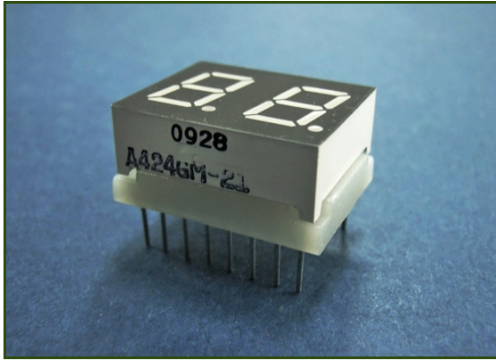

MATERIAL : NYLON 66(UL)
 FLAME CLASS : 94V-0/94V-2
 COLOR : BLACK/NATURAL
 UNIT: mm

用途: 可快速将8字型LED灯固定垫高在PCB板上

PART NO	A	PACKAGE
LEDSS-265	4.0	1000
LEDSS-266	5.0	1000
LEDSS-267	6.0	1000
LEDSS-268	7.0	1000
LEDSS-269	8.0	1000

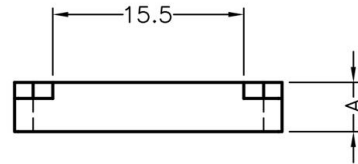
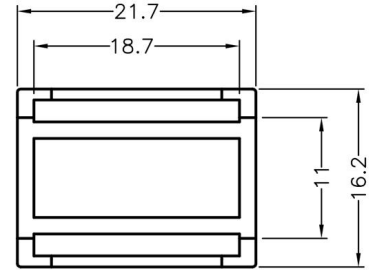

LED间隔柱 LED SPACER SUPPORT



MATERIAL : NYLON 66(UL)
 FLAME CLASS : 94V-0/94V-2
 COLOR : BLACK/NATURAL
 UNIT: mm

用途: 使LED灯柱立于PCB板上, 高度一致, 不断脚

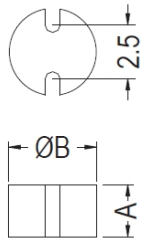

- Material: TPE
- Color: Black

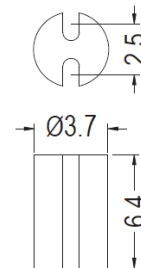

PART NO	A	B	PACKAGE
LEDSS-270	2.4	4.0	2000
LEDSS-381	5.0	4.0	1000
LEDSS-468	7.0	3.7	2000

PART NO	PACKAGE
LEDSS-386	1000

LED间隔柱 LED SPACER SUPPORT



MATERIAL : NYLON 66(UL)
 FLAME CLASS : 94V-0/94V-2
 COLOR : BLACK/NATURAL
 UNIT: mm

用途: 使LED灯柱立于PCB板上, 高度一致, 不断脚

(规格 / 尺寸) 代码说明:

L: LED建议装配规格 P: 装配灯数

PART NO	A	L	P	PACKAGE
LEDSS-271	5.0	5	1	1000
LEDSS-272	9.0	5	1	1000
LEDSS-273	11.0	5	1	1000
LEDSS-274	14.5	5	1	1000
LEDSS-385	8.0	5	1	1000
LEDSS-423	5.5	5	1	1000

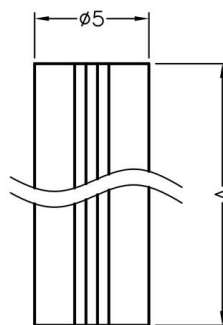
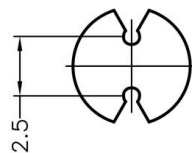

LED间隔柱 LED SPACER SUPPORT



MATERIAL : NYLON 66(UL)
 FLAME CLASS : 94V-0/94V-2
 COLOR : BLACK/NATURAL
 UNIT: mm

用途: 使LED灯柱立于PCB板上, 高度一致, 不断脚

(规格 / 尺寸) 代码说明:

P: 装配灯数

PART NO	A	P	PACKAGE
LEDSS-275	16.1	1	1000
LEDSS-276	16.4	1	1000
LEDSS-277	17.5	1	1000
LEDSS-278	20.2	1	1000
LEDSS-279	22.0	1	1000
LEDSS-280	22.7	1	1000
LEDSS-281	23.5	1	1000
LEDSS-282	26.0	1	1000

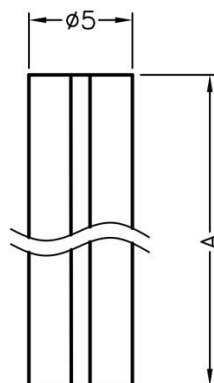
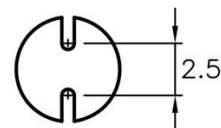

LED间隔柱 LED SPACER SUPPORT



MATERIAL : NYLON 66(UL)
 FLAME CLASS : 94V-0/94V-2
 COLOR : BLACK/NATURAL
 UNIT: mm

用途: 将3PIN Ø5mm的LED灯柱固定于PCB板上, 高度一致, 不断脚。

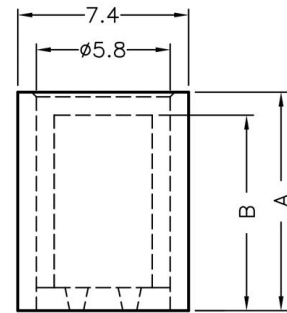
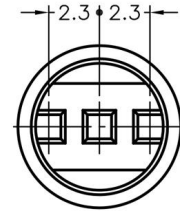

(规格 / 尺寸) 代码说明:

L: LED建议装配规格 P: 装配灯数

PART NO	A	B	L	P	PACKAGE
LEDSS-283	4.0	3.0	5.0	1	1000
LEDSS-284	6.0	5.0	5.0	1	1000
LEDSS-285	9.5	8.5	5.0	1	1000
LEDSS-286	11.5	10.5	5.0	1	1000

LED间隔柱 LED SPACER SUPPORT

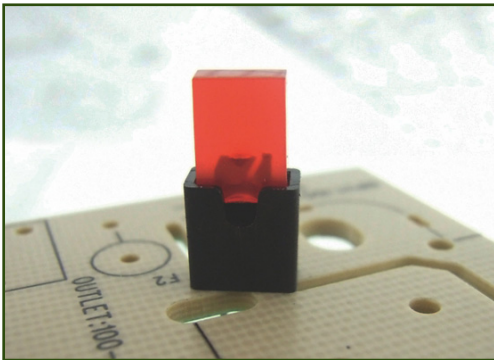

MATERIAL : NYLON 66(UL)
 FLAME CLASS : 94V-0/94V-2
 COLOR : BLACK
 UNIT: mm

用途: 把方型LED灯柱固定在PCB板上, 使LED灯柱高度一致, 不断脚。

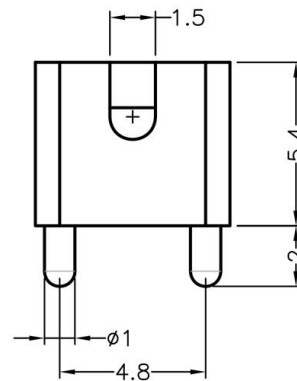
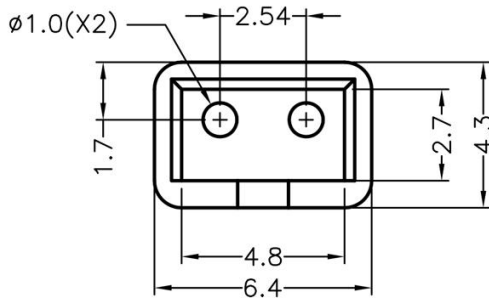

PART NO	P	PACKAGE
LEDSS-287	1	2000

(规格 / 尺寸) 代码说明:

P: 装配灯数

LED间隔柱 LED SPACER SUPPORT

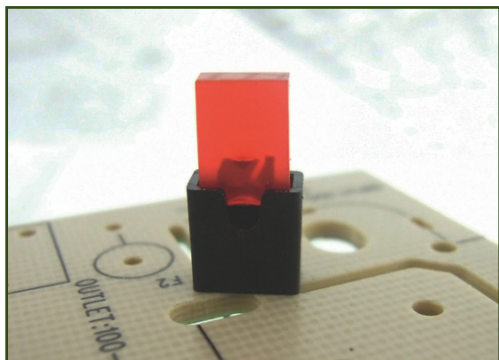

MATERIAL : NYLON 66(UL)
 FLAME CLASS : 94V-0/94V-2
 COLOR : BLACK/NATURAL
 UNIT: mm

用途: 把方型LED灯柱固定在PCB板上, 使LED灯柱高度一致, 不断脚。

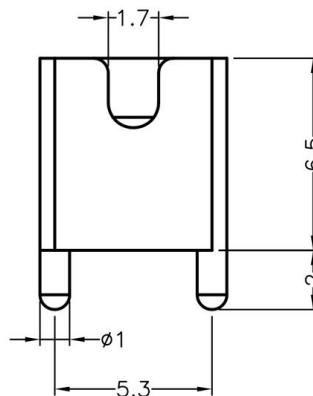
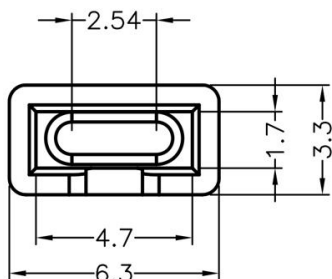

PART NO	P	PACKAGE
LEDSS-288	1	2000

(规格 / 尺寸) 代码说明:

P: 装配灯数

LED间隔柱 LED SPACER SUPPORT

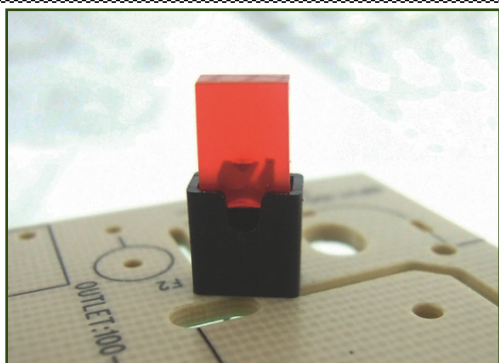

MATERIAL : NYLON 66(UL)
 FLAME CLASS : 94V-0/94V-2
 COLOR : BLACK
 UNIT: mm

用途: 把方型LED灯柱固定在PCB板上, 使LED灯柱高度一致, 不断脚。

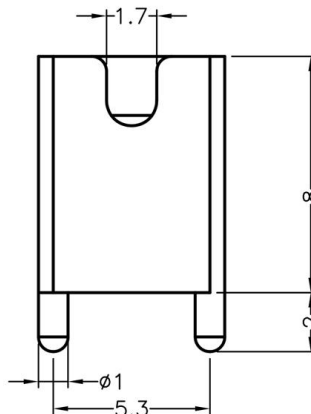
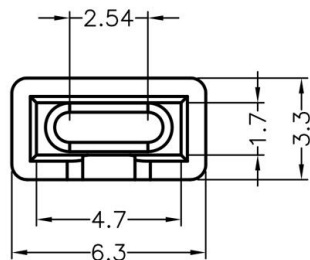

PART NO	P	PACKAGE
LEDSS-289	1	2000

(规格 / 尺寸) 代码说明:

P: 装配灯数

LED间隔柱 LED SPACER SUPPORT



MATERIAL : NYLON 66(UL)
 FLAME CLASS : 94V-0/94V-2
 COLOR : BLACK/NATURAL
 UNIT: mm

用途: 使LED灯柱固定于PCB板上, 使LED灯柱高度一致, 不断脚。

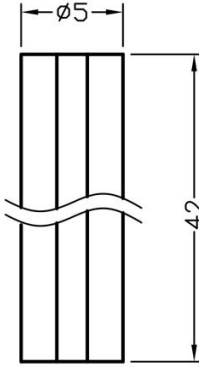
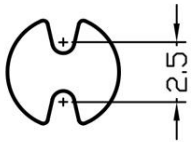

PART NO	P	PACKAGE
LEDSS-290	1	1000

(规格 / 尺寸) 代码说明:

P : 装配灯数

LED间隔柱 LED SPACER SUPPORT

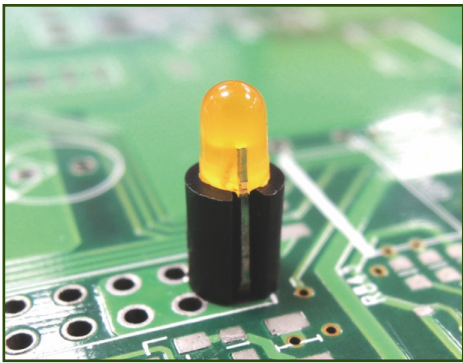

MATERIAL : NYLON 66(UL)
 FLAME CLASS : 94V-0/94V-2
 COLOR : BLACK/NATURAL
 UNIT: mm

用途: 使LED灯柱固定于PCB板上, 使LED灯柱高度一致, 不断脚。

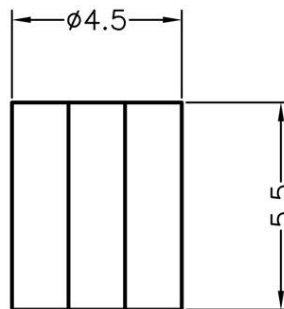
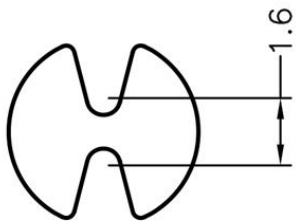

PART NO	L	P	PACKAGE
LEDSS-291	3.0	1	2000

(规格 / 尺寸) 代码说明:

L : LED建议装配规格 P : 装配灯数

LED间隔柱 LED SPACER SUPPORT

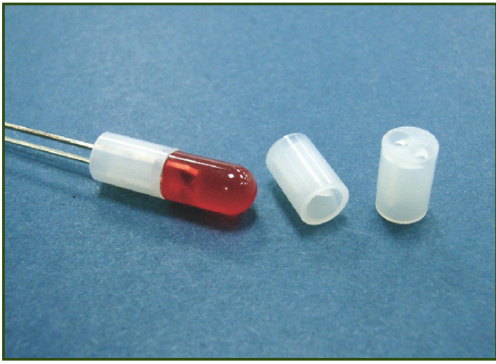

MATERIAL : NYLON 66(UL)
 FLAME CLASS : 94V-0/94V-2
 COLOR : BLACK/NATURAL
 UNIT: mm

用途：用于保护Ø5mm的LED灯柱立于PCB板上，使LED灯柱高度一致，接脚不会弯曲、折断、短路。

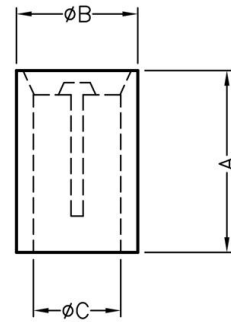
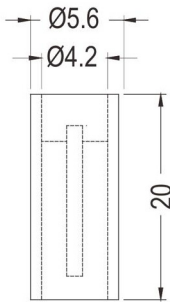
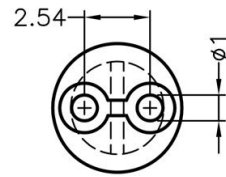
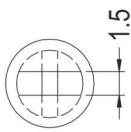

PART NO	PACKAGE
LEDSS-305	1000

PART NO	A	B	C	PACKAGE
LEDSS-292	2.0	5.6	3.5	2000
LEDSS-293	5.0	5.0	3.6	2000
LEDSS-294	7.5	5.0	3.6	2000
LEDSS-295	9.0	5.0	3.6	2000
LEDSS-296	12.0	5.0	3.6	2000
LEDSS-297	15.0	5.6	4.2	2000
LEDSS-298	16.0	5.6	4.2	1000
LEDSS-299	18.5	5.6	4.2	1000
LEDSS-300	19.0	5.6	4.2	1000
LEDSS-301	21.0	5.6	4.2	1000
LEDSS-302	21.5	5.6	4.2	1000
LEDSS-303	22.0	5.6	4.2	1000
LEDSS-304	23.5	5.6	4.2	1000
LEDSS-337	17.0	5.6	4.2	1000

LED间隔柱 LED SPACER SUPPORT

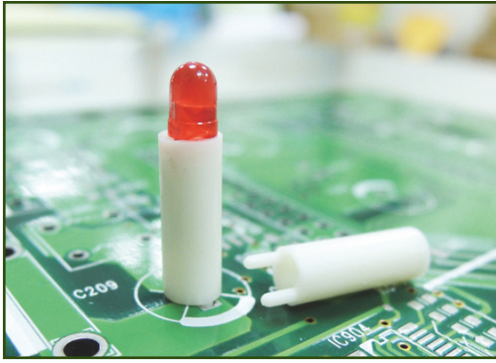

MATERIAL : NYLON 66(UL)
 FLAME CLASS : 94V-0/94V-2
 COLOR : BLACK/NATURAL
 UNIT: mm

用途: 用于保护Ø3mm的LED灯柱固定在PCB板上, 使LED灯柱高度一致, 中间隔板设计, 接脚不会弯曲、折断、短路, 有定位脚, 不倾斜。

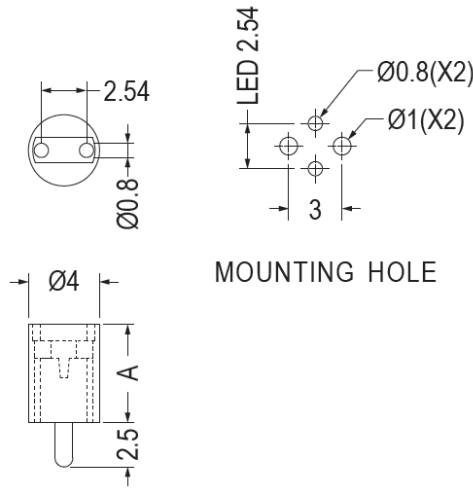

PART NO	A	PACKAGE
LEDSS-306	8.5	1000
LEDSS-307	6.0	1000
LEDSS-308	11.0	1000
LEDSS-309	12.0	1000
LEDSS-310	15.0	1000
LEDSS-311	17.0	1000
LEDSS-388	23.0	1000
LEDSS-389	5.5	1000
LEDSS-390	7.0	1000
LEDSS-391	9.0	1000
LEDSS-392	10.0	1000
LEDSS-393	13.0	1000
LEDSS-394	14.0	1000

LED间隔柱 LED SPACER SUPPORT

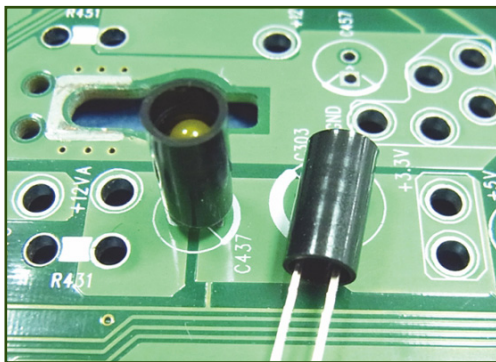

MATERIAL : NYLON 66(UL)
 FLAME CLASS : 94V-0/94V-2
 COLOR : BLACK/NATURAL
 UNIT: mm

用途: 保护Ø3mm的LED灯柱立于PCB板上, 使LED灯柱高度一致, 不断脚, 不漏光。

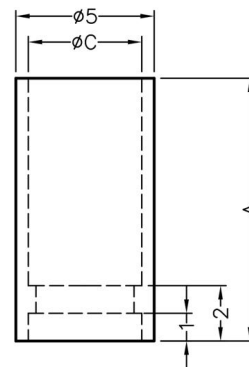
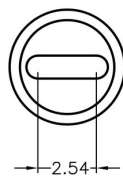

PART NO	A	C	L	P	PACKAGE
LEDSS-312	9.5	Ø4.1	3.0	1	1000
LEDSS-314	8.0	Ø4.1	3.0	1	1000

(规格 / 尺寸) 代码说明:

L: LED建议装配规格 P: 装配灯数

LED间隔柱 LED SPACER SUPPORT

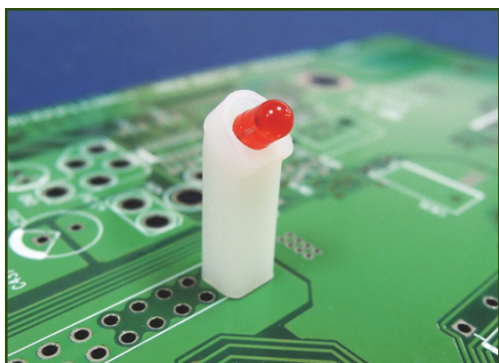

MATERIAL : NYLON 66(UL)
 FLAME CLASS : 94V-0/94V-2
 COLOR : BLACK/NATURAL
 UNIT: mm

用途: 使 $\varnothing 3\text{mm}$ 的LED灯柱成斜角安装在PC 板上, 高度一致, 不断脚

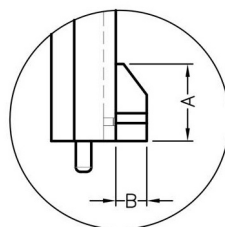
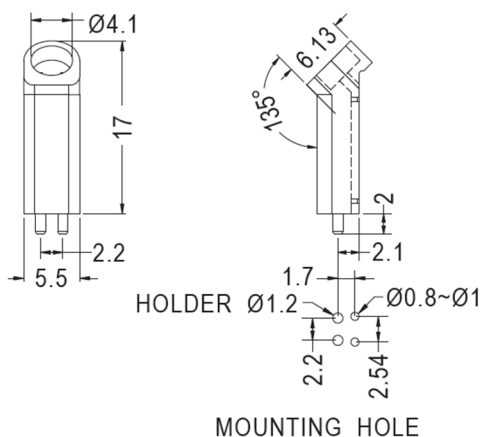

FOR LEDSS-313

(规格 / 尺寸) 代码说明:

L: LED建议装配规格 P: 装配灯数

PART NO	A	B	C	L	P	PACKAGE
LEDSS-313	5.0	2.0	$\varnothing 4.1$	3.0	1	1000
LEDSS-421	-	-	$\varnothing 4.1$	3.0	1	1000

LED间隔柱 LED SPACER SUPPORT

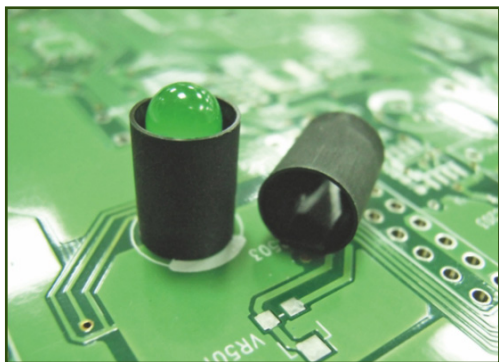

MATERIAL : NYLON 66(UL)
 FLAME CLASS : 94V-0/94V-2
 COLOR : BLACK/NATURAL
 UNIT: mm

用途: 用于保护 $\varnothing 5\text{mm}$ 的LED灯柱安装在PCB板上, 使LED灯柱高度一致, 不断脚, 有遮光效果, 不漏光。

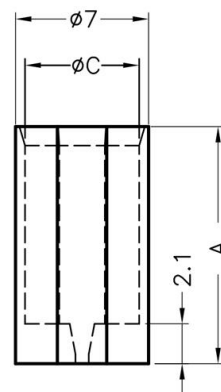
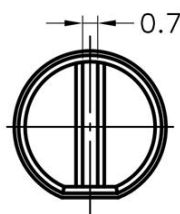

(规格 / 尺寸) 代码说明:

L: LED建议装配规格 P: 装配灯数

PART NO	A	C	L	P	PACKAGE
LEDSS-315	9.0	$\varnothing 6.0$	5.0	1	2000
LEDSS-316	12.5	$\varnothing 6.0$	5.0	1	1000

LED间隔柱 LED SPACER SUPPORT

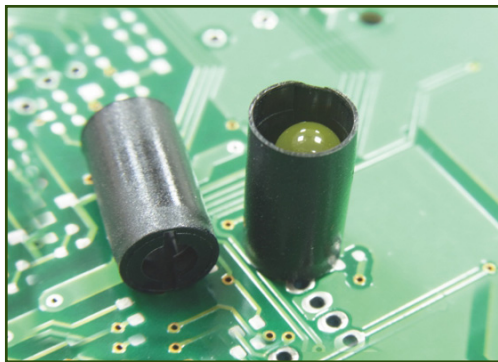

MATERIAL : NYLON 66(UL)
 FLAME CLASS : 94V-0/94V-2
 COLOR : BLACK/NATURAL
 UNIT: mm

用途: 保护 $\varnothing 5\text{mm}$ 的LED灯柱立于PCB板上, 使LED灯柱高度一致, 不断脚, 有遮光效果, 不漏光。

(规格 / 尺寸) 代码说明:

L: LED建议装配规格 P: 装配灯数

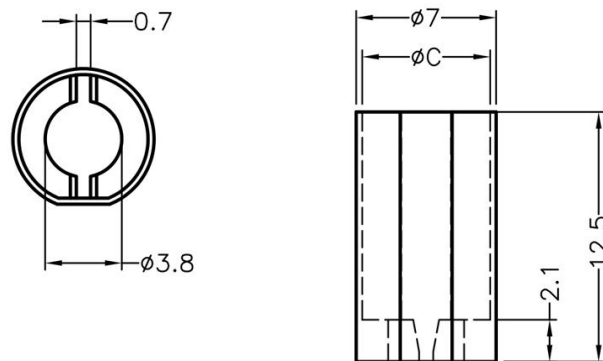

PART NO	C	L	P	PACKAGE
LEDSS-318	$\varnothing 6.4$	5.0	1	1000

LED间隔柱 LED SPACER SUPPORT

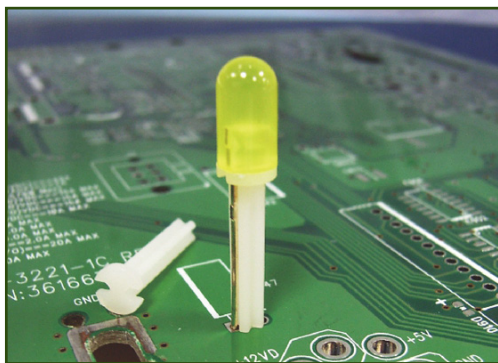

MATERIAL : ABS(UL)
 FLAME CLASS : 94HB
 COLOR : NATURAL
 UNIT: mm

用途: 使LED灯柱站立于PCB板上, 高度一致, 不断脚。

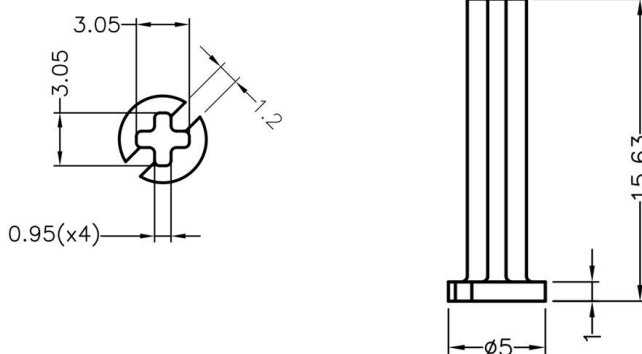

(规格 / 尺寸) 代码说明:

L: LED建议装配规格 P: 装配灯数

PART NO	L	P	PACKAGE
LEDSS-317	5.0	1	2000

LED间隔柱 LED SPACER SUPPORT



MATERIAL : NYLON 66(UL)
 FLAME CLASS : 94V-0/94V-2
 COLOR : BLACK/NATURAL
 UNIT: mm

用途: 使LED灯固定于PCB板上, 高度一致, 不断脚。

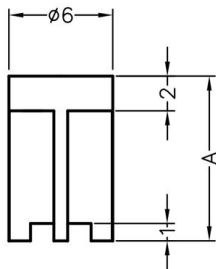
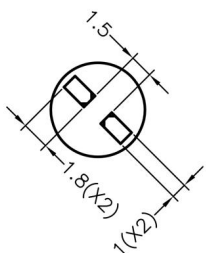

(规格 / 尺寸) 代码说明:

L: LED建议装配规格 P: 装配灯数

PART NO	A	L	P	PACKAGE
LEDSS-319	9.5	5.0	1	2000
LEDSS-320	22.2	5.0	1	2000
LEDSS-436	4.8	5.0	1	2000
LEDSS-437	6.5	5.0	1	2000
LEDSS-438	12.7	5.0	1	2000
LEDSS-439	19.1	5.0	1	2000
LEDSS-440	25.4	5.0	1	2000

LED间隔柱 LED SPACER SUPPORT

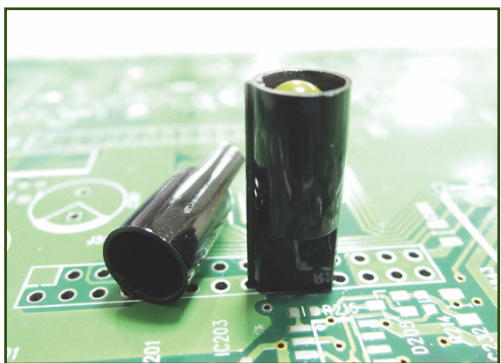

MATERIAL : NYLON 66(UL)
 FLAME CLASS : 94V-0/94V-2
 COLOR : BLACK/NATURAL
 UNIT: mm

用途: 用于保护ø5mmLED灯立于PC板上, 使LED灯高度一致, 不断脚, 有遮光效果, 不漏光。

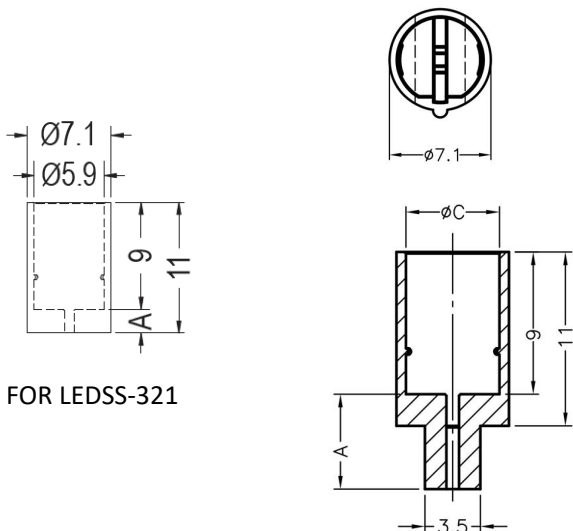

FOR LEDSS-321

(规格 / 尺寸) 代码说明:

L: LED建议装配规格 P: 装配灯数

PART NO	A	C	L	P	PACKAGE
LEDSS-321	2.0	ø5.9	5.0	1	2000
LEDSS-322	3.0	ø5.9	5.0	1	2000
LEDSS-323	4.0	ø5.9	5.0	1	2000
LEDSS-324	5.0	ø5.9	5.0	1	2000
LEDSS-325	6.0	ø5.9	5.0	1	2000
LEDSS-326	7.0	ø5.9	5.0	1	2000
LEDSS-327	8.0	ø5.9	5.0	1	2000
LEDSS-328	9.0	ø5.9	5.0	1	2000
LEDSS-329	10.0	ø5.9	5.0	1	2000

LED间隔柱 LED SPACER SUPPORT

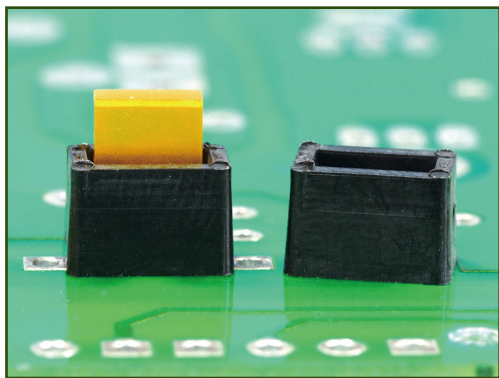

MATERIAL : NYLON 66(UL)
 FLAME CLASS : 94V-0/94V-2
 COLOR : BLACK
 UNIT: mm

用途: 保护LED灯固定在PCB板上, 使LED灯接脚不会弯曲、折断、短路, 并使 LED灯高度一致

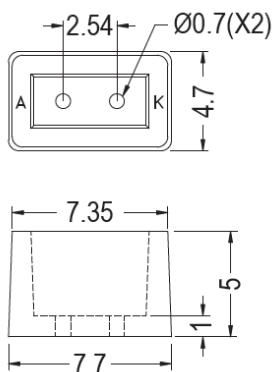

(规格 / 尺寸) 代码说明:

P: 装配灯数

PART NO	P	PACKAGE
LEDSS-330	1	2000

LED间隔柱 LED SPACER SUPPORT

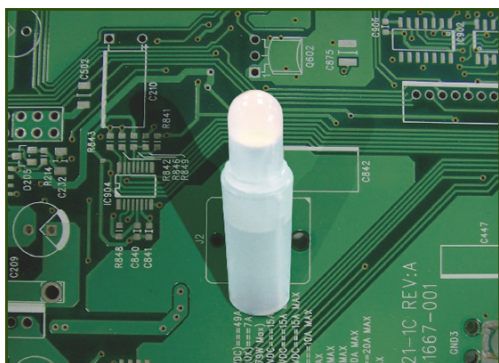

MATERIAL : NYLON 66(UL)
 FLAME CLASS : 94V-0/94V-2
 COLOR : BLACK/NATURAL
 UNIT: mm

用途: 将3pin Ø3的LED灯立于PCB板上, 使LED灯高度一致, 不断脚

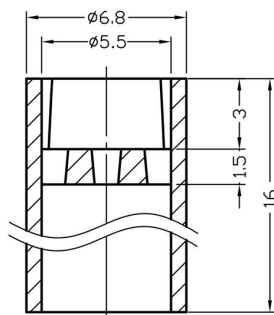
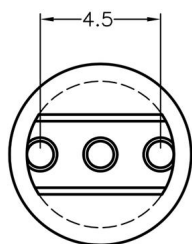

(规格 / 尺寸) 代码说明:

L: LED建议装配规格 P: 装配灯数

PART NO	L	P	PACKAGE
LEDSS-331	3.0	1	2000

LED间隔柱 LED SPACER SUPPORT

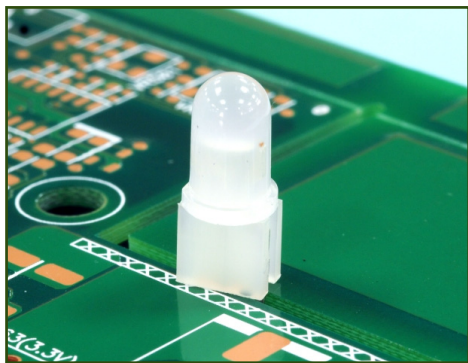

MATERIAL : NYLON 66(UL)
 FLAME CLASS : 94V-0/94V-2
 COLOR : BLACK/NATURAL
 UNIT: mm

用途：用于3PIN的LED之垫高及固定，有定位脚，不歪斜。

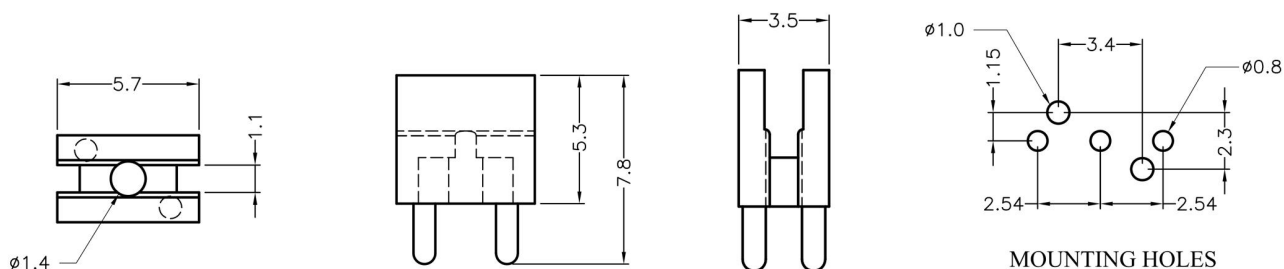

PART NO	PACKAGE
LEDSS-332	1000

LED间隔柱 LED SPACER SUPPORT

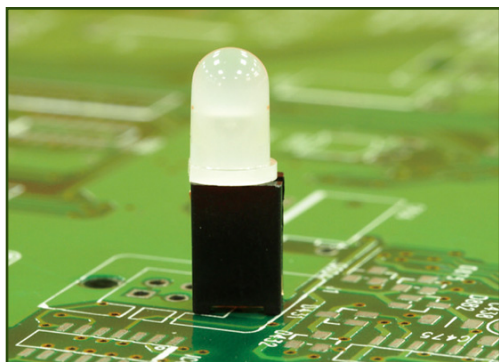

MATERIAL : NYLON 46(UL)
 FLAME CLASS : 94V-0
 COLOR : BLACK
 UNIT: mm

用途：保护LED灯固定在PCB板上，使LED灯接脚不会弯曲、折断、短路，并使LED灯高度一致。

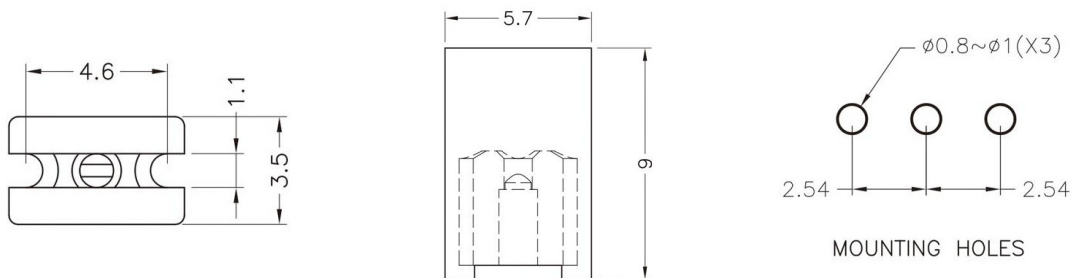

PART NO	PACKAGE
LEDSS-333	1000

LED间隔柱 LED SPACER SUPPORT

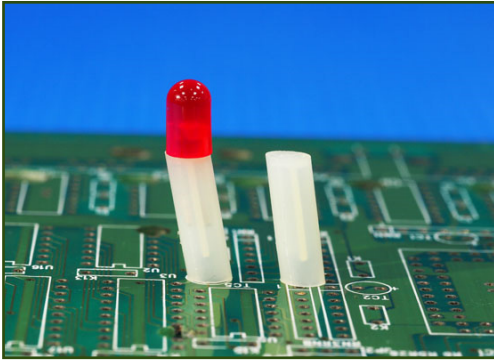

MATERIAL : NYLON 66(UL)
 FLAME CLASS : 94V-0/94V-2
 COLOR : BLACK/NATURAL
 UNIT: mm

用途: 使LED灯成80.5°焊在PCB板上, 高度一致, 不断脚, 中间有隔板不短路.

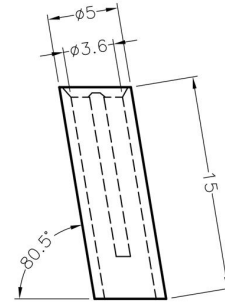
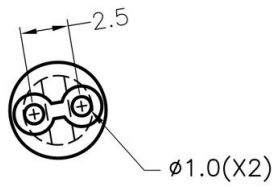

PART NO	P	PACKAGE
LEDSS-334	1	1000

(规格 / 尺寸) 代码说明:

P : 装配灯数

LED间隔柱 LED SPACER SUPPORT

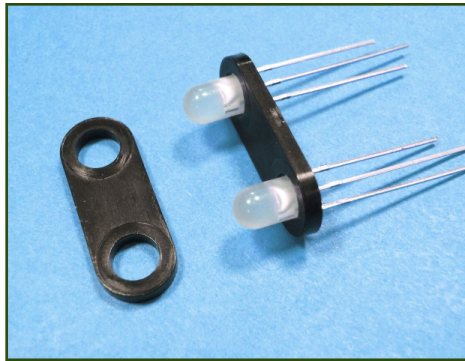

MATERIAL : NYLON 46(UL)
 FLAME CLASS : 94V-0/94V-2
 COLOR : BLACK/NATURAL
 UNIT: mm

用途: 配合LED定位.

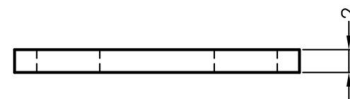
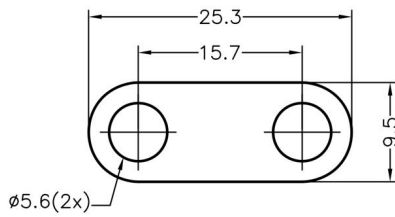

PART NO	PACKAGE
LEDSS-335	1000

LED间隔柱 LED SPACER SUPPORT

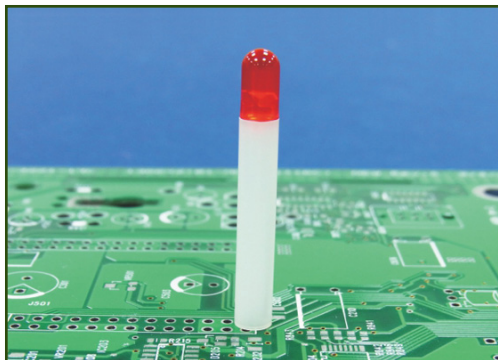

MATERIAL : NYLON 66(UL)
 FLAME CLASS : 94V-0/94V-2
 COLOR : BLACK/NATURAL
 UNIT: mm

用途: 用于保护 $\varnothing 5\text{mm}$ 的LED灯柱直立在PCB板上, 使LED灯柱高度一致, 保护LED灯柱接脚不会弯曲、折断、短路。

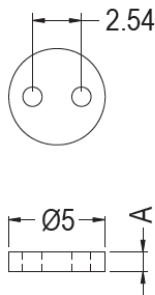

PART NO	A	PACKAGE
LEDSS-336	1.0	2000

LED间隔柱 LED SPACER SUPPORT

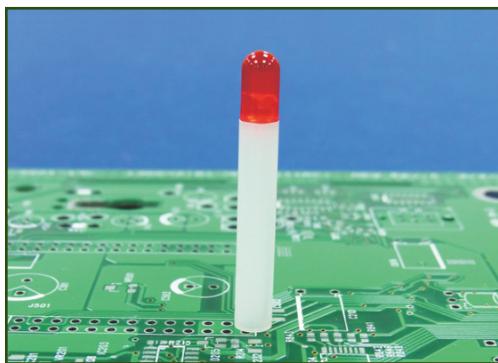

MATERIAL : NYLON 46(UL)
 FLAME CLASS : 94V-0/94V-2
 COLOR : BLACK/NATURAL
 UNIT: mm

用途: 用于保护 $\varnothing 5\text{mm}$ 的LED灯柱直立在PCB板上, 使LED灯柱高度一致, 保护LED灯柱接脚不会弯曲、折断、短路。

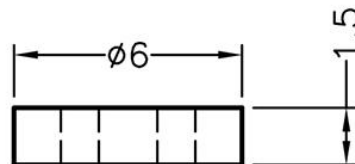
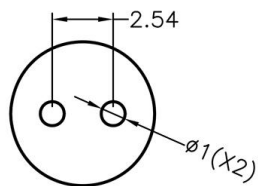

PART NO	A	L	P	PACKAGE
LEDSS-338	1.5	5.0	1	2000

(规格 / 尺寸) 代码说明:

L: LED建议装配规格 P: 装配灯数

LED间隔柱 LED SPACER SUPPORT

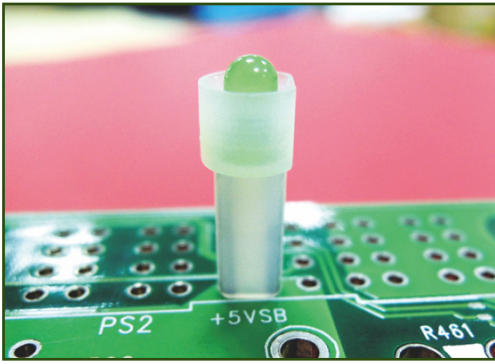

MATERIAL : NYLON 46(UL)

FLAME CLASS : 94V-0/94V-2

COLOR : BLACK/NATURAL

UNIT: mm

用途: 用于保护 $\varnothing 3\text{mm}$ 的LED灯矗立在PCB板上, 使LED灯高度一致, 不断脚, 有遮光效果, 不漏光。

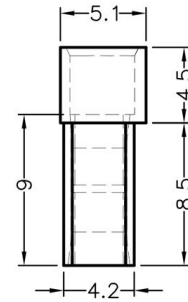
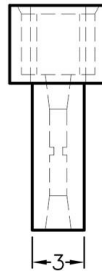
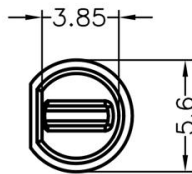

PART NO	PACKAGE
LEDSS-378	2000

LED间隔柱 LED SPACER SUPPORT

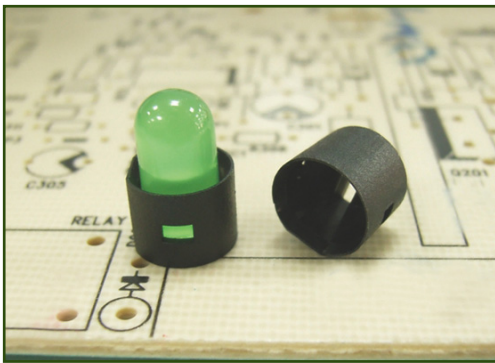

MATERIAL : NYLON 66(UL)

FLAME CLASS : 94V-0/94V-2

COLOR : BLACK/NATURAL

UNIT: mm

用途: 用于保护 $\varnothing 5\text{mm}$ 的LED灯固定在PCB板上, 使LED等高度一致, 不断脚, 不漏光。

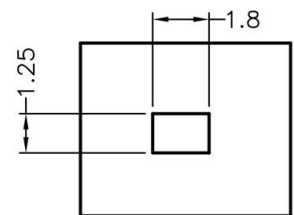
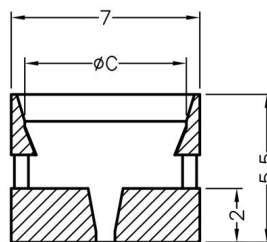
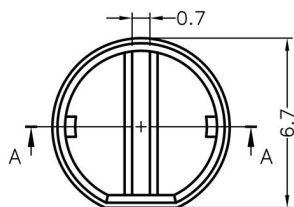

SECTION A-A

PART NO	C	PACKAGE
LEDSS-123	$\varnothing 6.0$	2000

1.适用 $\varnothing 5\text{mm}$ LED灯帽

2.可以用于2PIN、3PIN的LED灯柱

LED间隔柱 LED SPACER SUPPORT

用途：用于保护 $\varnothing 3\text{mm}$ 的LED灯柱直立在PCB板上，使LED灯柱高度一致，保护LED灯柱接脚不会弯曲、折断、短路,尺寸齐全。

MATERIAL : NYLON 66(UL)

FLAME CLASS : 94V-0/94V-2

COLOR : BLACK/NATURAL

UNIT: mm

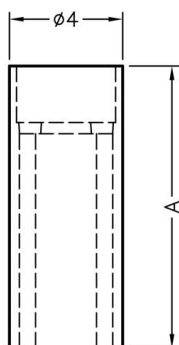
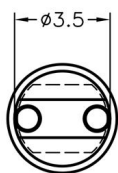
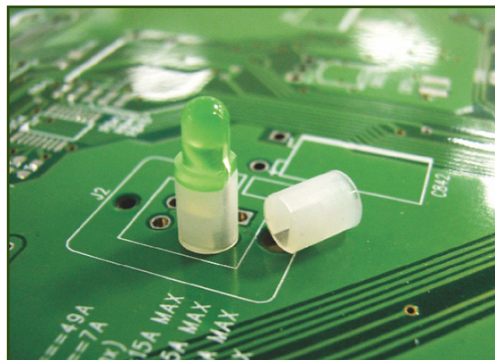

(规格 / 尺寸) 代码说明:

L: LED建议装配规格 P: 装配灯数

PART NO	A	L	P	PACKAGE
LEDSS-341	3.0	3.0	1	2000
LEDSS-342	4.0	3.0	1	2000
LEDSS-343	4.5	3.0	1	2000
LEDSS-344	5.0	3.0	1	2000
LEDSS-345	5.5	3.0	1	2000
LEDSS-346	6.0	3.0	1	2000
LEDSS-347	6.5	3.0	1	2000
LEDSS-348	7.0	3.0	1	2000
LEDSS-349	7.5	3.0	1	2000
LEDSS-350	8.0	3.0	1	2000
LEDSS-351	8.5	3.0	1	2000
LEDSS-352	9.0	3.0	1	2000
LEDSS-353	9.5	3.0	1	2000
LEDSS-354	10.0	3.0	1	2000
LEDSS-355	11.0	3.0	1	2000
LEDSS-356	11.5	3.0	1	2000
LEDSS-357	12.0	3.0	1	2000
LEDSS-358	12.5	3.0	1	2000
LEDSS-359	13.0	3.0	1	2000
LEDSS-360	13.5	3.0	1	2000
LEDSS-361	14.5	3.0	1	2000
LEDSS-362	15.0	3.0	1	2000
LEDSS-363	15.5	3.0	1	2000
LEDSS-364	16.0	3.0	1	2000
LEDSS-365	16.5	3.0	1	2000
LEDSS-366	17.0	3.0	1	1000
LEDSS-367	17.5	3.0	1	1000
LEDSS-368	18.0	3.0	1	1000
LEDSS-369	18.5	3.0	1	1000
LEDSS-370	19.0	3.0	1	1000
LEDSS-371	20.0	3.0	1	1000
LEDSS-372	20.5	3.0	1	1000
LEDSS-373	21.0	3.0	1	1000
LEDSS-374	21.5	3.0	1	1000
LEDSS-375	22.0	3.0	1	1000
LEDSS-376	22.5	3.0	1	1000
LEDSS-377	23.0	3.0	1	1000

LED间隔柱 LED SPACER SUPPORT

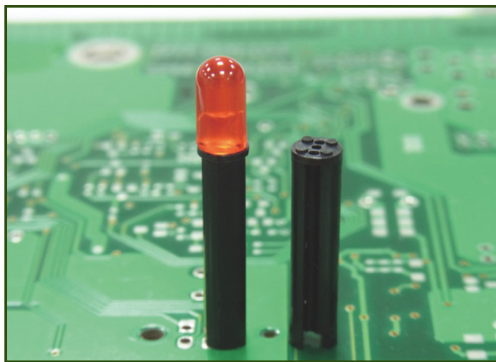

MATERIAL : PBT(UL)
 FLAME CLASS : 94V-0
 COLOR : BLACK
 UNIT: mm

用途：用于保护Ø5mm的LED灯直立于PCB板上，使高度一致，接脚不会弯曲、折断、短路。

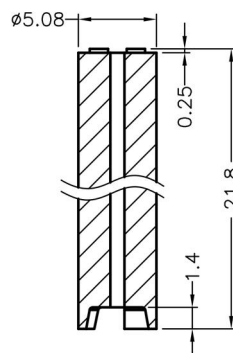
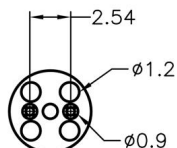

PART NO	PACKAGE
LEDSS-379	1000

LED间隔柱 LED SPACER SUPPORT



MATERIAL : NYLON 66(UL)
 FLAME CLASS : 94V-0/94V-2
 COLOR : BLACK/NATURAL
 UNIT: mm

用途：把3PIN直径Ø3mm的LED灯固定在PCB板上，保持LED灯柱高度一致，不断脚。

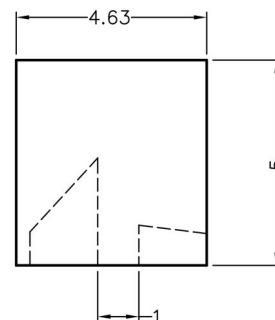
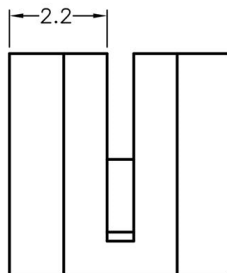
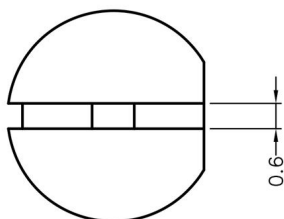

PART NO	PACKAGE
LEDSS-380	2000

LED间隔柱 LED SPACER SUPPORT

LED间隔柱



MATERIAL : TPE

COLOR : BLACK

UNIT: mm

用途: 使LED立于PC板上, 高度一致, 不断脚

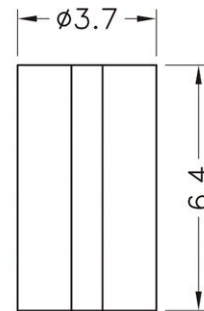
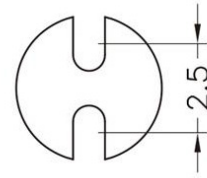

PART NO	PACKAGE
LEDSS-386	1000

LED间隔柱 LED SPACER SUPPORT

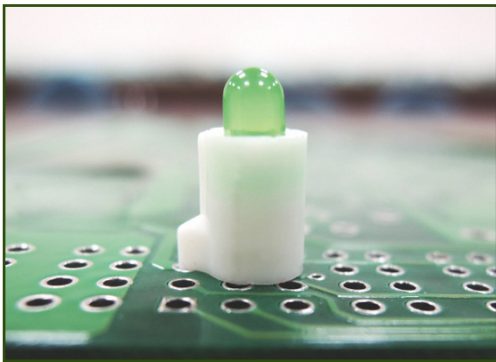

用途: 用于保护2PIN Ø3mm的LED灯焊于PCB板上, 高度一致, 有定位脚, 不歪斜

MATERIAL : NYLON 66(UL)

FLAME CLASS : 94V-0/94V-2

COLOR : BLACK/NATURAL

UNIT: mm

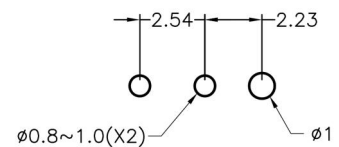
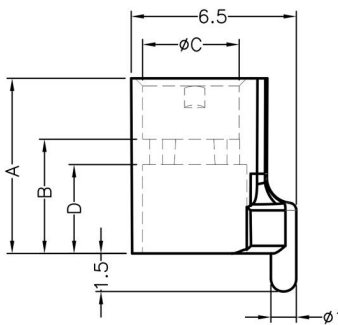
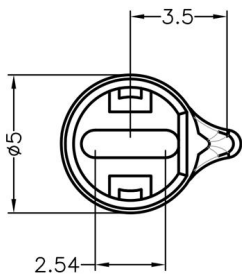

MOUNTING HOLES

PART NO	A	B	C	D	PACKAGE
LEDSS-395	6.9	4.5	Ø3.8	3.5	1000
LEDSS-396	8.5	5.5	Ø3.8	4.5	1000

LED间隔柱 LED SPACER SUPPORT



用途：可快速将 $\varnothing 3$ mm LED固定于机器面板上

MATERIAL : NYLON 66(UL)
 FLAME CLASS : 94V-0/94V-2
 COLOR : BLACK/NATURAL
 UNIT: mm

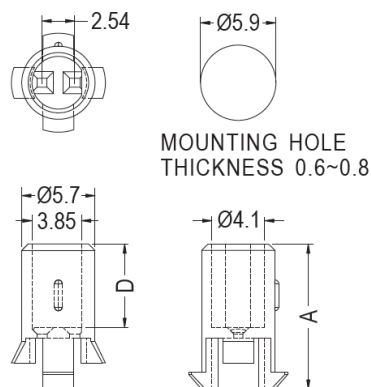

PART NO	A	D	PACKAGE
LEDSS-397	11.3	6.5	2000
LEDSS-398	12.8	8.0	2000

LED间隔柱 LED SPACER SUPPORT

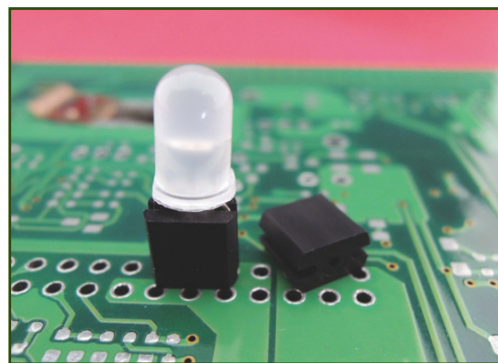

用途：使 LED灯立于PCB板上，高度一致，不断脚。

MATERIAL : NYLON 66(UL)
 FLAME CLASS : 94V-0/94V-2
 COLOR : BLACK/NATURAL
 UNIT: mm

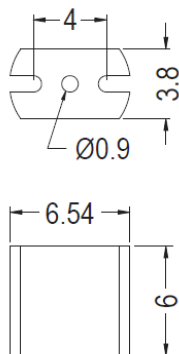

(规格 / 尺寸) 代码说明:

L: LED建议装配规格 P: 装配灯数

PART NO	L	P	PACKAGE
LEDSS-399	5.0	1	1000

LED间隔柱 LED SPACER SUPPORT



用途：配合螺丝，可将2pin、3pin Ø3的LED固定在机板上。

MATERIAL : NYLON 66(UL)
 FLAME CLASS : 94V-0/94V-2
 COLOR : BLACK
 UNIT: mm

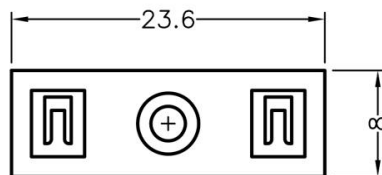
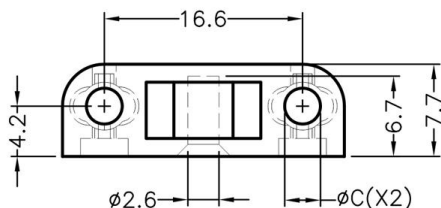

PART NO	C	L	P	PACKAGE
LEDSS-401	Ø3.0	3.0	2	1000

(规格 / 尺寸) 代码说明:

L: LED建议装配规格 P: 装配灯数

LED间隔柱 LED SPACER SUPPORT

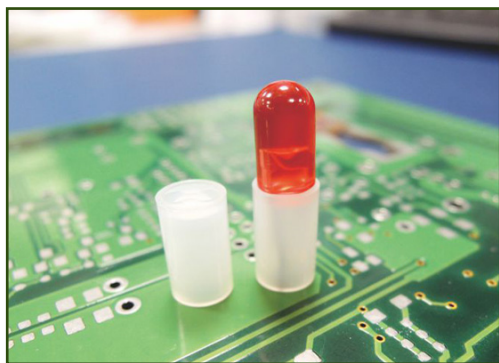

用途：使LED灯立于PCB板上，高度一致，不断脚。

MATERIAL : NYLON 66(UL)
 FLAME CLASS : 94V-0/94V-2
 COLOR : BLACK/NATURAL
 UNIT: mm

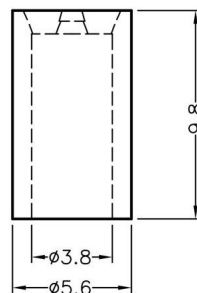
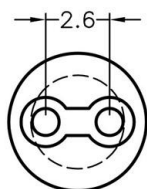

PART NO	L	P	PACKAGE
LEDSS-402	5.0	1	2000

(规格 / 尺寸) 代码说明:

L: LED建议装配规格 P: 装配灯数

LED间隔柱 LED SPACER SUPPORT

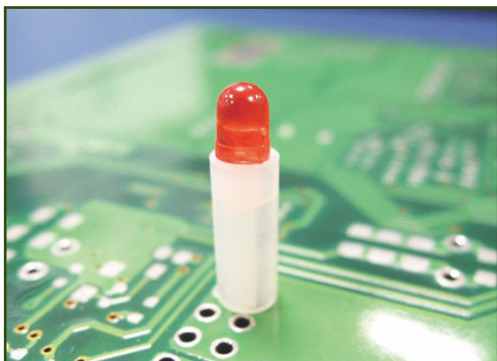

用途：用于保护LED灯立于PCB板上，使LED灯高度一致，接脚不会、弯曲、折断、短路

MATERIAL : NYLON 66(UL)
 FLAME CLASS : 94V-0/94V-2
 COLOR : BLACK/NATURAL
 UNIT: mm

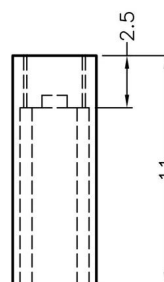
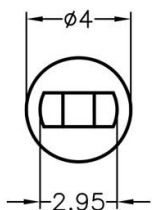

PART NO	L	P	PACKAGE
LEDSS-403	3.0	1	2000

(规格 / 尺寸) 代码说明:

L: LED建议装配规格 P: 装配灯数

LED间隔柱 LED SPACER SUPPORT



用途：使 LED灯立于PCB板上，高度一致，不断脚。

MATERIAL : NYLON 66(UL)
 FLAME CLASS : 94V-0/94V-2
 COLOR : BLACK/NATURAL
 UNIT: mm

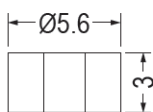
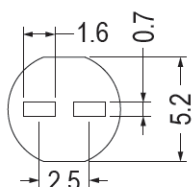

(规格 / 尺寸) 代码说明:

L: LED建议装配规格 P: 装配灯数

PART NO	L	P	PACKAGE
LEDSS-404	5.0	1	2000

LED间隔柱 LED SPACER SUPPORT

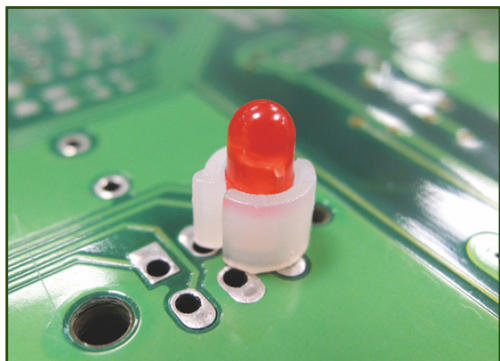

用途：用于保护LED灯矗立在PCB板上，使LED灯高度一致，接脚不会、弯曲、折断、短路

MATERIAL : NYLON 66(UL)
 FLAME CLASS : 94V-0/94V-2
 COLOR : BLACK/NATURAL
 UNIT: mm

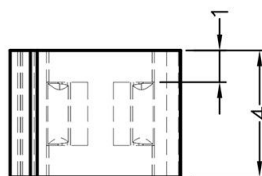
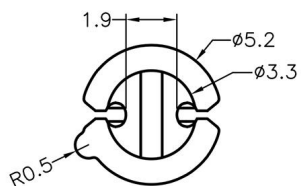

(规格 / 尺寸) 代码说明:

L: LED建议装配规格 P: 装配灯数

PART NO	L	P	PACKAGE
LEDSS-405	3.0	1	2000

LED间隔柱 LED SPACER SUPPORT

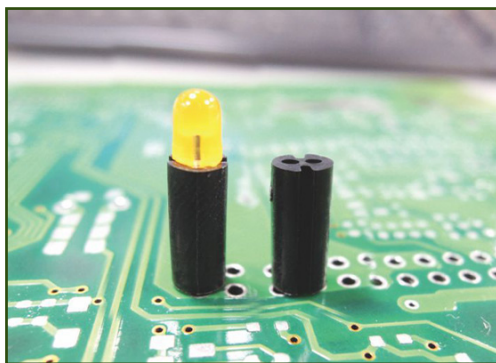

用途：使 LED灯直立在PCB板上，高度一致，不断脚。

MATERIAL : TPE
 COLOR : BLACK
 UNIT: mm

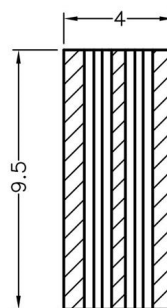
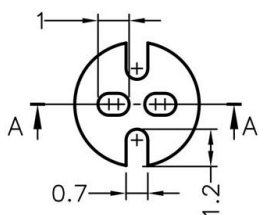

SECTION A-A

PART NO	L	P	PACKAGE
LEDSS-406	3.0	1	2000

(规格 / 尺寸) 代码说明:

L: LED建议装配规格 P: 装配灯数

LED间隔柱 LED SPACER SUPPORT

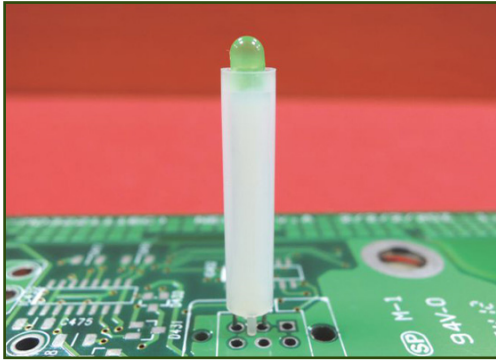

用途：用于保护LED灯站立于PCB板上，使LED灯高度一致，接脚不会、弯曲、折断、短路

MATERIAL : NYLON 66(UL)
 FLAME CLASS : 94V-0/94V-2
 COLOR : BLACK/NATURAL
 UNIT: mm

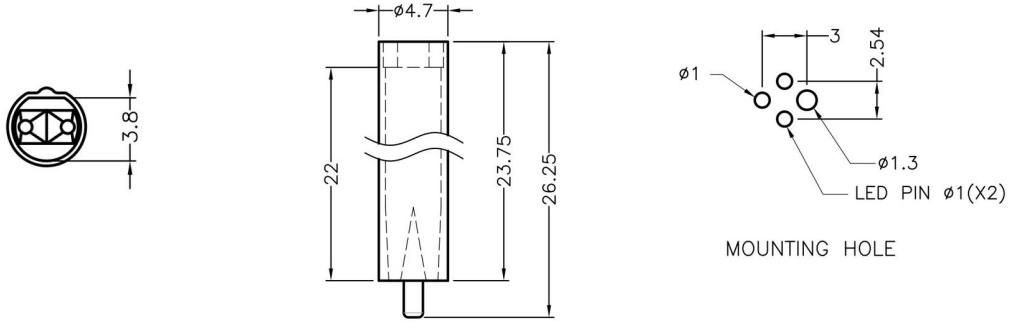

PART NO	L	P	PACKAGE
LEDSS-407	3.0	1	1000

(规格 / 尺寸) 代码说明:

L: LED建议装配规格 P: 装配灯数

LED间隔柱 LED SPACER SUPPORT

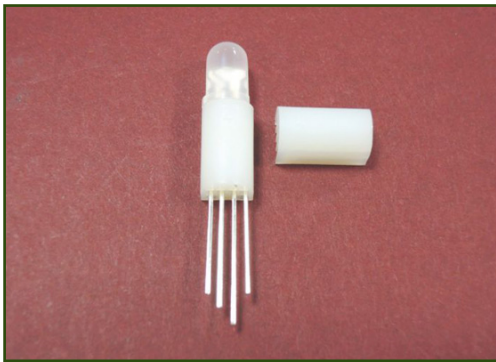

用途：用于保护LED灯站立于PCB板上，保持LED灯高度一致，不断脚。

MATERIAL : NYLON 66(UL)
 FLAME CLASS : 94V-0/94V-2
 COLOR : BLACK/NATURAL
 UNIT: mm

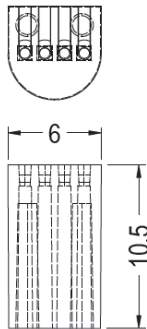

(规格 / 尺寸) 代码说明:

L: LED灯建议装配规格 P: 装配灯数

PART NO	L	P	PACKAGE
LEDSS-408	5.0	1	2000

LED间隔柱 LED SPACER SUPPORT



用途：可快速将 $\varnothing 3\text{mm}$ 的LED灯固定于机器面板上

MATERIAL : NYLON 66(UL)
 FLAME CLASS : 94V-0/94V-2
 COLOR : BLACK
 UNIT: mm

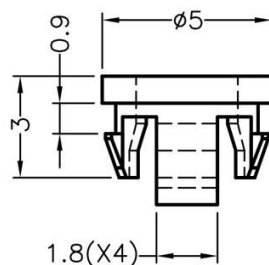
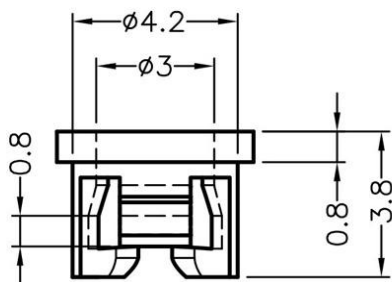

CHASSIS $\varnothing 4.3\text{mm}$
 THICKNESS 0.8mm

PART NO	L	P	PACKAGE
LEDSS-409	3.0	1	2000

(规格 / 尺寸) 代码说明:

L: LED灯建议装配规格 P: 装配灯数

LED间隔柱 LED SPACER SUPPORT

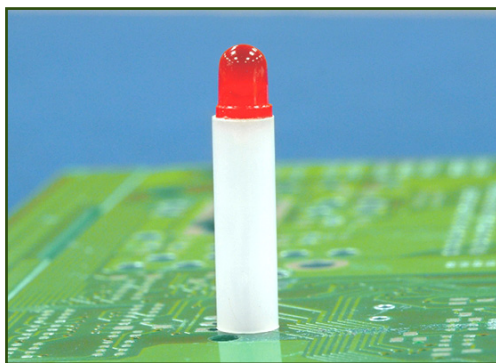

用途：使LED灯直立在PCB板上，保持LED灯高度一致，不断脚。

MATERIAL : NYLON 66(UL)
 FLAME CLASS : 94V-0/94V-2
 COLOR : BLACK/NATURAL
 UNIT: mm

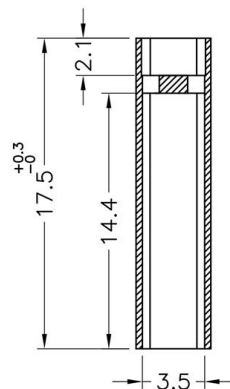
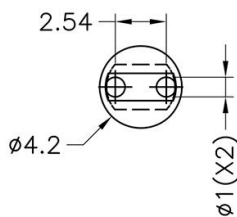

PART NO	PACKAGE
LEDSS-411	1000

LED间隔柱 LED SPACER SUPPORT

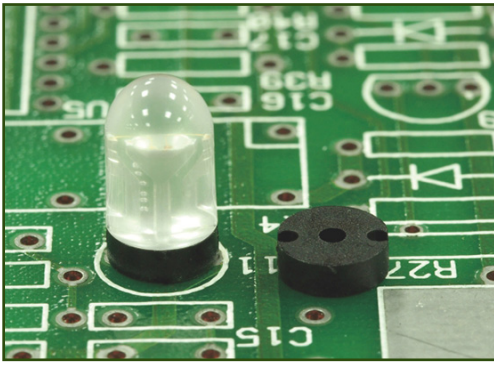

用途：使LED灯直立于PCB板上，高度一致，不断脚

MATERIAL : NYLON 66(UL)
 FLAME CLASS : 94V-0/94V-2
 COLOR : BLACK/NATURAL
 UNIT: mm

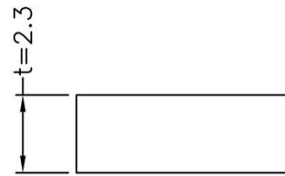
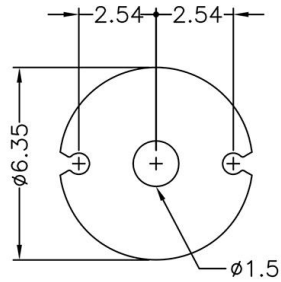

PART NO	PACKAGE
LEDSS-412	2000

LED间隔柱 LED SPACER SUPPORT

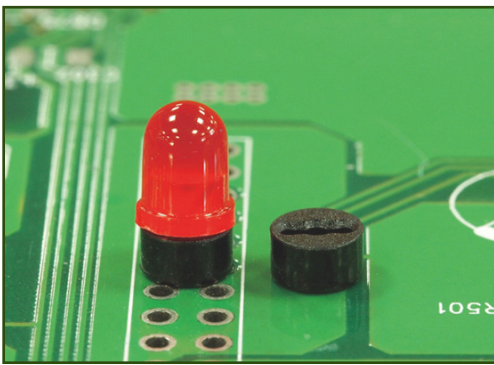

用途：安装LED灯在PCB板上，保持LED灯高度一致，不断脚。

MATERIAL : NYLON 66(UL)
 FLAME CLASS : 94V-0/94V-2
 COLOR : BLACK/NATURAL
 UNIT: mm

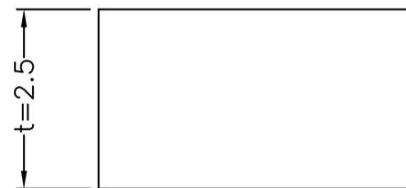
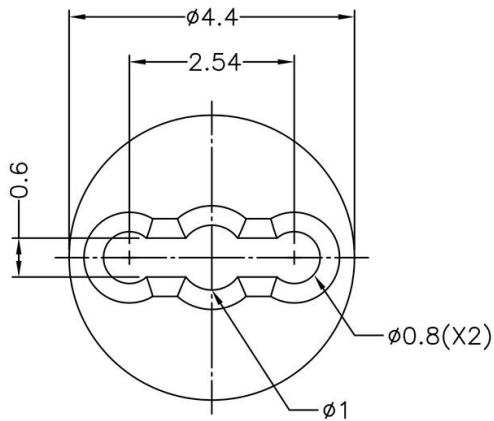

PART NO	PACKAGE
LEDSS-413	1000

LED间隔柱 LED SPACER SUPPORT



用途：固定4pin Ø5mm的LED灯焊在PCB板上，保持LED灯高度一致，有定位脚，不倾斜。

MATERIAL : NYLON 66(UL)
 FLAME CLASS : 94V-0/94V-2
 COLOR : BLACK/NATURAL
 UNIT: mm

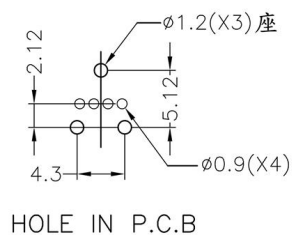
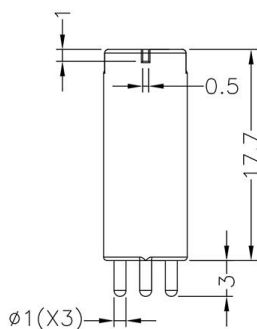
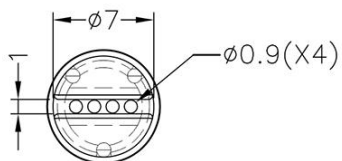

PART NO	PACKAGE
LEDSS-414	1000

LED间隔柱 LED SPACER SUPPORT

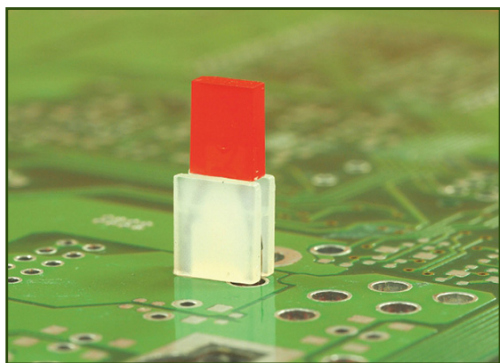

用途：保护LED灯固定在PCB板上，使LED灯接脚不会弯曲、折断、短路，并使LED灯高度一致。

MATERIAL : NYLON 66(UL)
 FLAME CLASS : 94V-0/94V-2
 COLOR : BLACK/NATURAL
 UNIT: mm

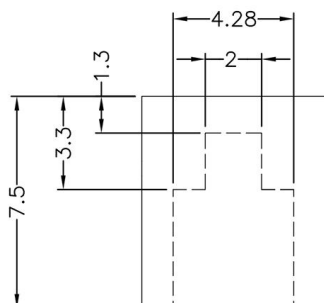
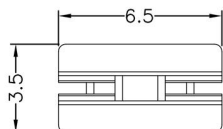

PART NO	PACKAGE
LEDSS-415	2000

LED间隔柱 LED SPACER SUPPORT

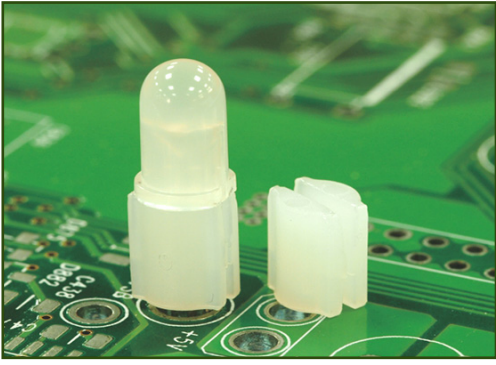

用途：保护4pin LED灯固定在PCB板上，使LED灯接脚不会弯曲、折断、短路，并使LED灯高度一致。

MATERIAL : NYLON 66(UL)
 FLAME CLASS : 94V-0/94V-2
 COLOR : BLACK/NATURAL
 UNIT: mm

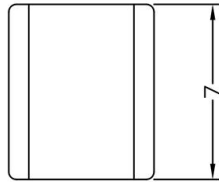
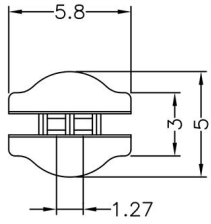

PART NO	PACKAGE
LEDSS-416	2000

LED间隔柱 LED SPACER SUPPORT

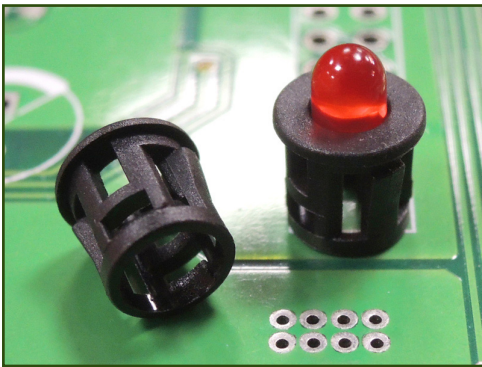

用途：可快速将LED灯固定在机器面板上

MATERIAL : NYLON 66(UL)
 FLAME CLASS : 94V-0/94V-2
 COLOR : BLACK/NATURAL
 UNIT: mm

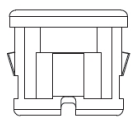
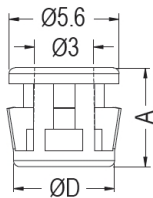

CHASSIS: ØG
 THICKNESS: T

(规格 / 尺寸) 代码说明:

- 1.适用Ø3LED灯帽
- 2.适用2PIN/3PIN的LED灯

PART NO	A	D	G	T	PACKAGE
LEDSS-417	5.0	Ø5.2	Ø5.2	1.1	1000
LEDSS-418	5.2	Ø4.95	Ø5.0	0.8	1000

LED间隔柱 LED SPACER SUPPORT

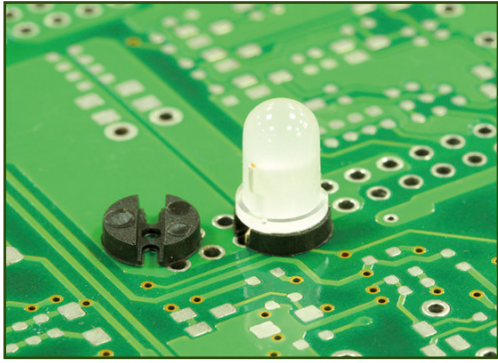

用途：使LED立于PC板上，高度一致，不断脚

MATERIAL : NYLON 66(UL)
 FLAME CLASS : 94V-0/94V-2
 COLOR : BLACK/NATURAL
 UNIT: mm

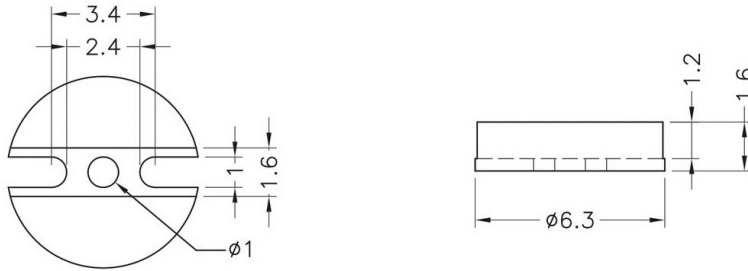

PART NO	PACKAGE
LEDSS-419	2000

LED间隔柱 LED SPACER SUPPORT

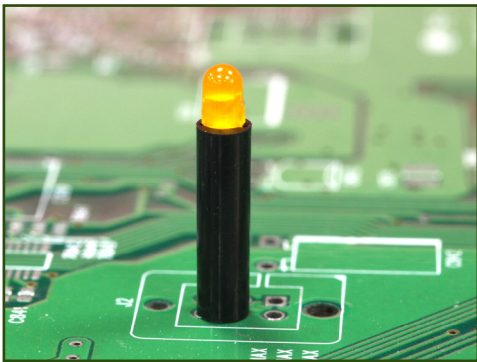

用途：使LED立于PC板上，高度一致，不断脚

MATERIAL : NYLON 66(UL)
 FLAME CLASS : 94V-0/94V-2
 COLOR : BLACK/NATURAL
 UNIT: mm

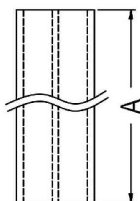
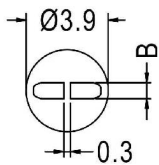

PART NO	A	B	PACKAGE
LEDSS-422	14.5	0.75	1000
LEDSS-424	18.0	0.76	1000

LED间隔柱 LED SPACER SUPPORT

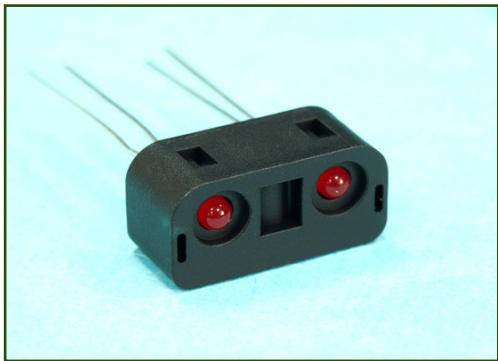

用途：配合螺丝，可将LED灯固定在机板上

MATERIAL : NYLON 66(UL)
 FLAME CLASS : 94V-0/94V-2
 COLOR : BLACK
 UNIT: mm

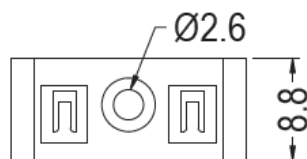
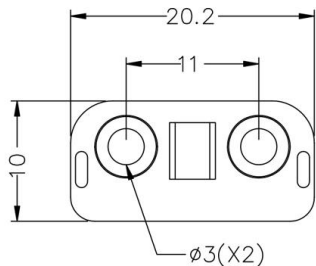

PART NO	PACKAGE
LEDSS-425	1000

LED间隔柱 LED SPACER SUPPORT

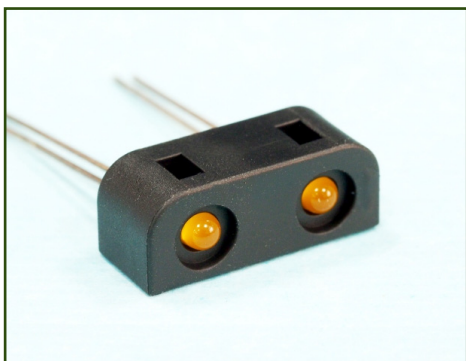

用途：配合螺丝，可将LED灯固定在机板上

MATERIAL : NYLON 66(UL)
 FLAME CLASS : 94V-0/94V-2
 COLOR : BLACK
 UNIT: mm

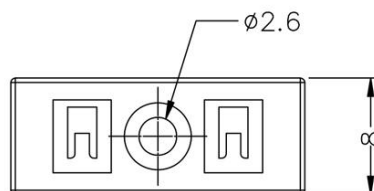
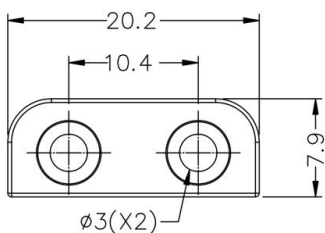

PART NO	PACKAGE
LEDSS-426	1000

LED间隔柱 LED SPACER SUPPORT

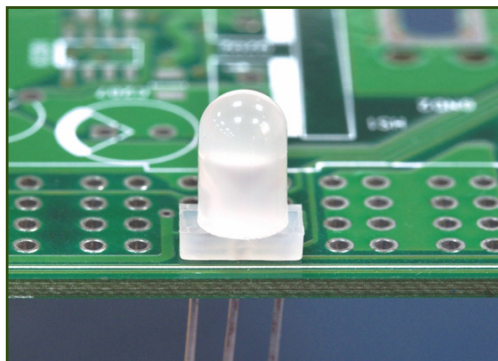

用途：保护LED灯固定在PCB板上，使LED灯接脚不会弯曲、折断、短路，并使LED灯高度一致。

MATERIAL : NYLON 66(UL)
 FLAME CLASS : 94V-0/94V-2
 COLOR : BLACK/NATURAL
 UNIT: mm

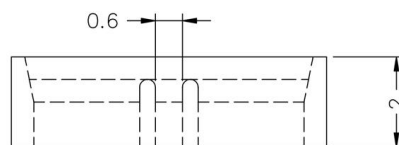
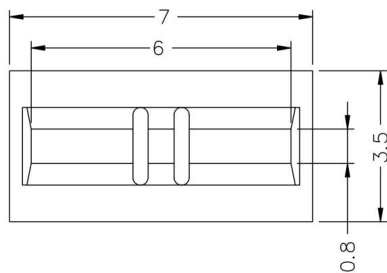

PART NO	PACKAGE
LEDSS-427	1000

LED间隔柱 LED SPACER SUPPORT

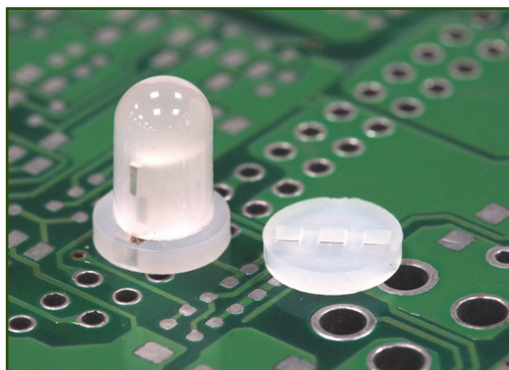

用途：把3PIN Ø5mm的LED灯固定在PCB板上，LED高度一致，不断脚。

MATERIAL : NYLON 66(UL)
 FLAME CLASS : 94V-0/94V-2
 COLOR : BLACK/NATURAL
 UNIT: mm

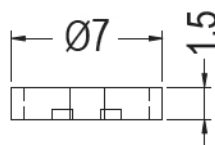
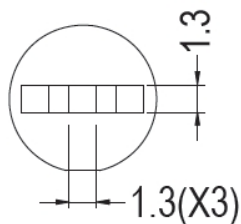

PART NO	PACKAGE
LEDSS-428	2000

LED间隔柱 LED SPACER SUPPORT

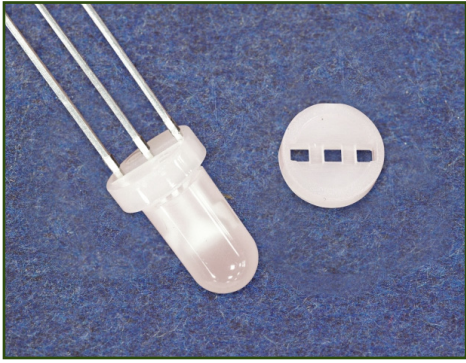

用途：把3PIN Ø5mm的LED灯固定在PCB板上，LED高度一致，不断脚。

MATERIAL : NYLON 66(UL)
 FLAME CLASS : 94V-0/94V-2
 COLOR : BLACK/NATURAL
 UNIT: mm

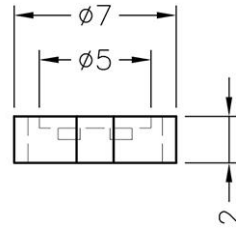
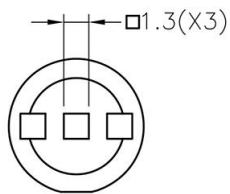

PART NO	PACKAGE
LEDSS-430	2000

LED间隔柱 LED SPACER SUPPORT

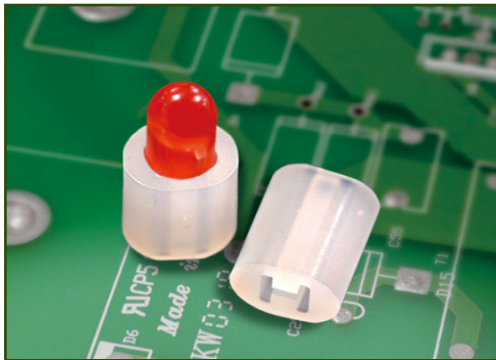

用途：使LED立于PCB板上，高度一致，不断脚。

MATERIAL : NYLON 66(UL)
 FLAME CLASS : 94V-0/94V-2
 COLOR : BLACK/NATURAL
 UNIT: mm

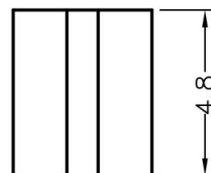
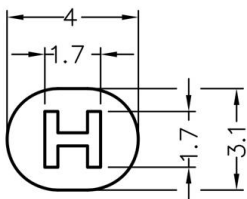

PART NO	PACKAGE
LEDSS-429	1000

LED间隔柱 LED SPACER SUPPORT

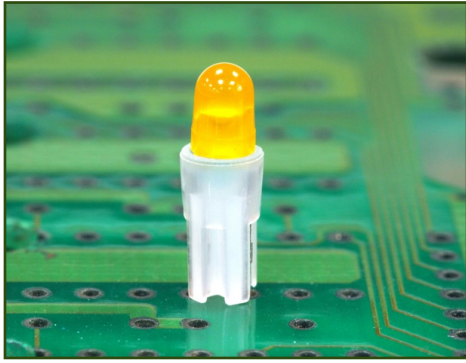

用途：使LED立于PC板上，高度一致，不断脚

MATERIAL : NYLON 66(UL)
 FLAME CLASS : 94V-0/94V-2
 COLOR : BLACK/NATURAL
 UNIT: mm

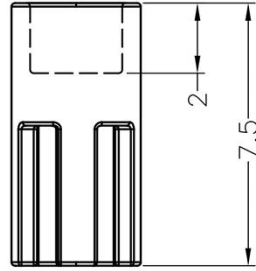
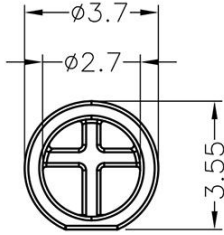

PART NO	PACKAGE
LEDSS-431	1000

LED间隔柱 LED SPACER SUPPORT

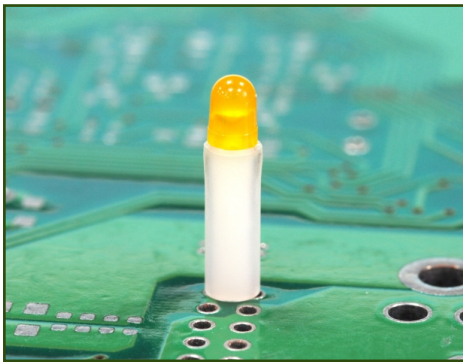

用途：使LED立于PC板上，高度一致，不断脚

MATERIAL : NYLON 66(UL)
 FLAME CLASS : 94V-0/94V-2
 COLOR : BLACK/NATURAL
 UNIT: mm

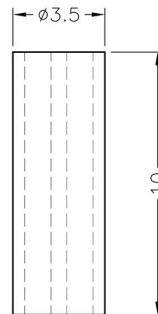
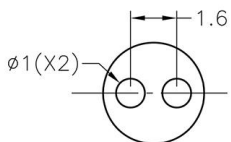

PART NO	PACKAGE
LEDSS-432	1000

LED间隔柱 LED SPACER SUPPORT

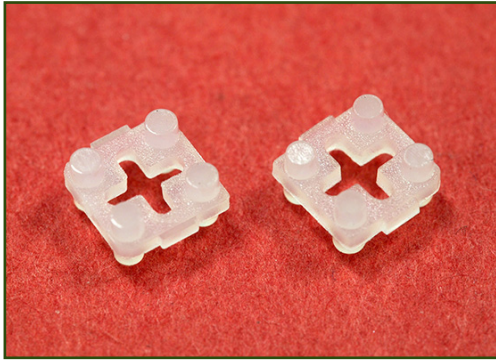

用途：使LED立于PC板上，高度一致，不断脚

MATERIAL : NYLON 66(UL)
FLAME CLASS : 94V-0/94V-2
COLOR : BLACK/NATURAL
UNIT: mm

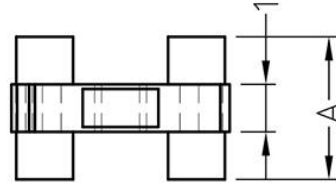
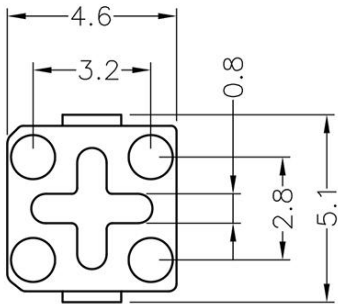

PART NO	A	PACKAGE
LEDSS-441	3.0	2000

LED间隔柱 LED SPACER SUPPORT

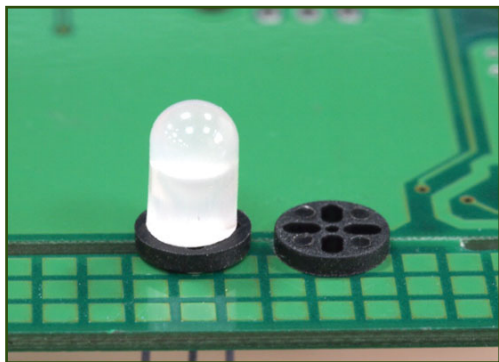

用途：使LED固定于PC板上，高度一致，不断脚

MATERIAL : TPE
 COLOR : BLACK
 UNIT: mm

MATERIAL : NYLON 66(UL)
 FLAME CLASS : 94V-0/94V-2
 COLOR : BLACK/NATURAL
 UNIT: mm

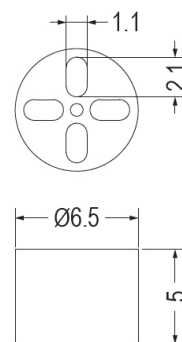
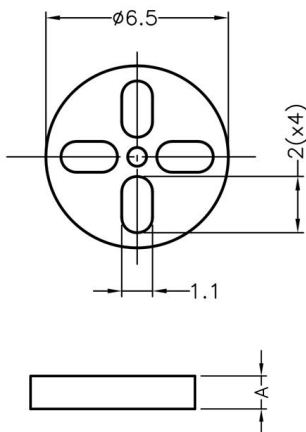

(规格 / 尺寸) 代码说明:

L : LED建议装配规格

P : 装配灯数

PART NO	A	L	P	PACKAGE
LEDSS-442	1.3	5.0	1	2000
LEDSS-443	7.9	5.0	1	2000

PART NO	PACKAGE
LEDSS-472	2000

LED间隔柱 LED SPACER SUPPORT

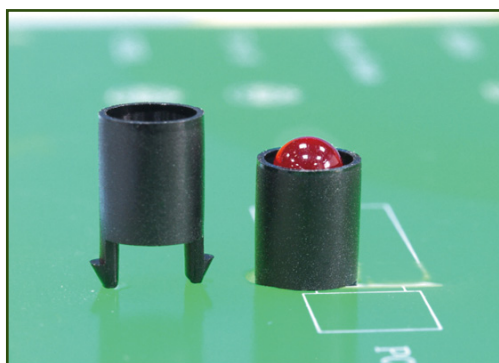

用途：可快速将Ø5mm LED固定于机板上。

MATERIAL : NYLON 66(UL)
 FLAME CLASS : 94V-0/94V-2
 COLOR : BLACK/NATURAL
 UNIT: mm

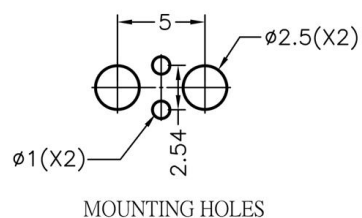
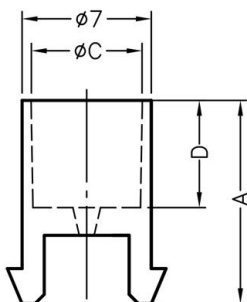

PART NO	A	C	D	L	P	PACKAGE
LEDSS-444	12.7	Ø6.0	7.0	5.0	1	2000
LEDSS-445	11.0	Ø6.0	5.8	5.0	1	2000

(规格 / 尺寸) 代码说明:

L : LED建议装配规格

P : 装配灯数

LED间隔柱 LED SPACER SUPPORT

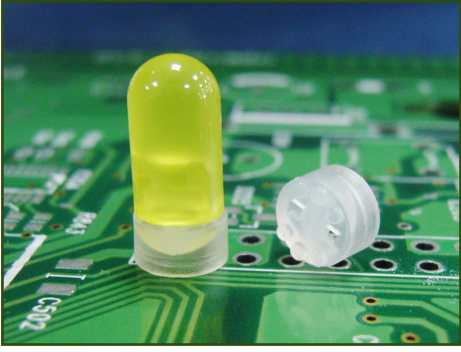

用途：使φ5mm LED立于PC板上，高度一致，不断脚

MATERIAL : NYLON 66(UL)
 FLAME CLASS : 94V-2,94V-0
 COLOR : BLACK/NATURAL
 UNIT: mm

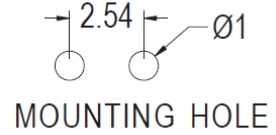
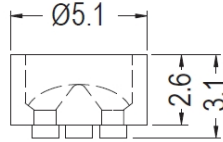
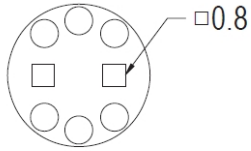

MOUNTING HOLE

PART NO	PACKAGE
LEDSS-447	2000

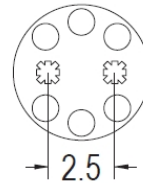
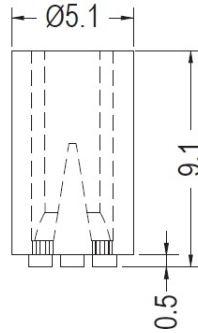
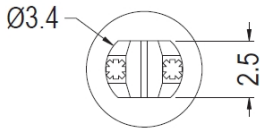

PART NO	PACKAGE
LEDSS-448	2000

LED间隔柱 LED SPACER SUPPORT

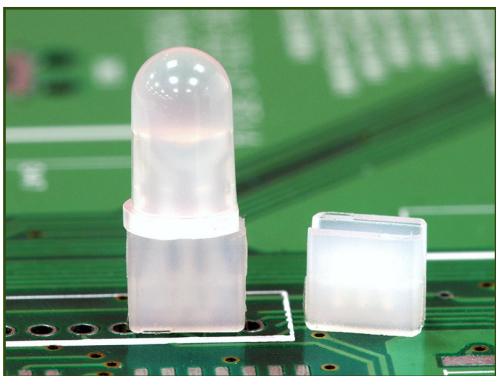

用途：保护4pin LED灯固定在PC板上，使LED灯接脚不会弯曲、折断、短路，并使LED灯高度一致。

MATERIAL : NYLON 66(UL)
 FLAME CLASS : 94V-2,94V-0
 COLOR : BLACK/NATURAL
 UNIT: mm

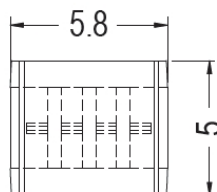
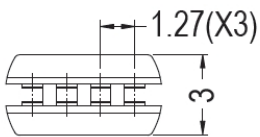

PART NO	PACKAGE
LEDSS-469	2000

LED间隔柱 LED SPACER SUPPORT

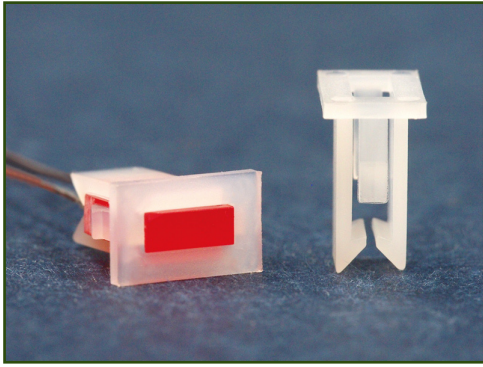

用途：可快速将5x2方型LED固定于机器面板上。

MATERIAL : NYLON 66(UL)

FLAME CLASS : 94V-2,94V-0

COLOR : BLACK/NATURAL

UNIT: mm

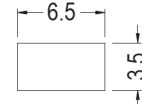
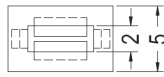

MOUNTING HOLE
THICKNESS 2.0

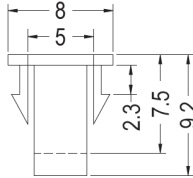

PART NO	PACKAGE
LEDSS-470	2000

LED间隔柱 LED SPACER SUPPORT

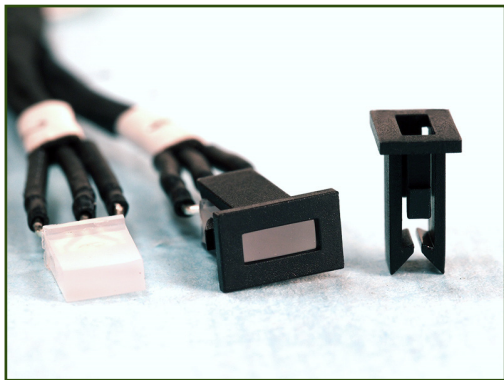

用途：可快速将5x2方型LED固定于机器面板上。

MATERIAL : NYLON 66(UL)

FLAME CLASS : 94V-2,94V-0

COLOR : BLACK/NATURAL

UNIT: mm

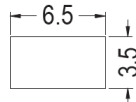
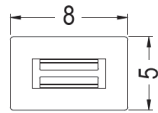

MOUNTING HOLE
THICKNESS 1.0

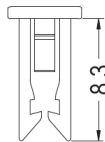
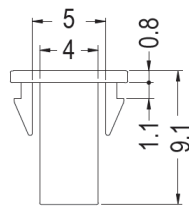

PART NO	PACKAGE
LEDSS-471	2000

电子电脑塑胶五金零件目录

1.LED间隔柱

2.LED导光柱 LED导光盖 LED遮光罩

3.LED座 LED座套 红外线灯罩 光纤座

4.90°LED灯座 45°LED灯座

5.PC板间隔柱 PC板隔离柱

6.塑料铜柱 尼龙柱 六角隔离柱 塑胶铜柱 铜柱 导光板隔离柱 圆体间隔柱 PC板固定定座 固定扣 电路板隔离柱 导电隔离柱

7.排线固定座 自粘式配线固定座 排线固定夹 压线板 电线固定座 扭线固定座 扭式固定环 扎线固定座 电源线固定座 电源线固定座插头固定扣 天线固定座 T8灯管固定座 风扇束线座 光纤固定座

8.PC板端子 接线插片端子 PC板焊接端子 接地片 圆形连接片 弹片 测试针 探针 测试点 保险丝座 保险丝盖 插式电线连接头 闭端端子 弹簧螺纹端子 压线帽 端子台 快速接线夹 跳线

9.仪表脚垫 插销式脚垫 螺丝固定脚垫 脚垫 抗震脚垫 磁铁脚垫 橡胶脚垫 自粘脚垫 银框脚垫 金框脚垫 橡胶垫圈 橡胶华司 橡胶垫片 硅胶脚垫

10.塑料螺丝 塑胶螺丝 翼型塑料螺丝 塑料螺帽 塑料螺帽 蝶形螺母 止付螺丝 紧定螺钉 内牙螺丝 螺丝帽盖 手转螺丝 手拧螺丝 滚花螺丝 手转螺母 手拧螺母

11.PC板拉柄 PC板耳把 PC板导槽 电路板导轨 PCB导轨槽 直立式导槽 电路板导轨

12.晶体管盖 电晶体盖 晶体管垫片 电晶体垫片 晶体管座 电晶体座 T-O3晶体管座 石英晶体垫片 垫圈 华司 垫片 TO-220晶体管座 光电晶体座 电晶体座 IR晶体座 霍尔晶体座 硅胶帽套 功率晶体导热硅片 功率晶体压板 电源固定压条 晶体管固定弹片 五金弹片 电晶体固定弹片 晶体管夹

电子电脑塑胶五金零件目录

13.电容器垫片 垫圈 华司 电容器座 电容器帽套 电容器固定座 电容器盖 电容器护套 压敏护套 硅胶帽套

14.热敏电阻座 电阻保护座 保护电阻器 可变电阻盖

15.陶瓷零件垫片 零件垫片 垫圈 华司 零件垫座 IC座 桥式整流座 跳线座 线圈座 滤波器垫片 绝缘柱 螺丝垫片 滚轮 PC板垫片 球击缓冲垫片 尼龙垫圈 尼龙弹簧垫片 散热陶瓷垫片

16.功率IC盖 桥式整流盖 保护盖 开关盖 硅胶盖 绝缘盖 电池盖 末端套管 软质端子保护套 PC端子保护套 喇叭座 拉柄箱扣 线圈固定座 DRAM固定带 十字型插件式固定器 轨道固定器

17.孔塞 扣式孔塞 扣式塞头 DVI防尘盖 螺丝孔孔塞 螺丝塞头 螺纹孔塞

18.电源线扣 电线固定夹 护线环 橡胶圈 护线圈 开口式护线环 橡胶线环 硅胶线环 硅胶护线环 天线护线环 方型护线环 U型护线环 抗震护线环 防震线环 抗震线环用插销 抗震线环用螺丝 硬盘驱动器防震座 透气压力平衡固定头 透气平衡压力固定扣

19.把手 机箱把手 仪器门拉手 纸箱把手 纸箱配件 打包扣 外箱护脚垫 纸箱外箱扣

20.阻尼齿轮 阻尼器 缓冲齿轮

21.电线扎带 电线束线带 固定带 扎线 电源线收线带 珠型扎带 水管座 扎带座 扎带扣 吊勾 粘扣带 绑线带

22.USB座护盖 USB端口保护盖 USB端口防尘盖 MICRO USB防尘盖 MINI USB座护盖 USB Type-C防尘盖 USB防尘盖 RJ-45防尘盖 RJ-11防尘盖 RJ-12防尘盖 RJ-22防尘盖 电源插头防尘盖 电源插头保护座 电源插头防尘座 电源插头防尘盖 光纤连接器护盖 光纤连接器护套 光纤防尘盖 PC板金手指防尘盖 HDMI防尘盖 Mini数位端子防尘盖 汽车点烟器防尘盖 BBU防尘盖 DVI防尘盖 连接器盖 SIM Card Cap防尘盖 SD防尘盖 KVM防尘盖 CF防尘盖 防尘盖 端子盖 S端子盖 平衡端子盖 BNC绝缘座 SATA防尘盖 ESATA护盖 DP端子防尘盖 Mini D.P数位端子防尘盖 D.Type防尘盖 VGA防尘盖 IDE Connector防尘盖 PC端子防尘盖 端子防尘盖 1394端子防尘盖 零件盖 电源盖 机板电源保护盖 连接器座 PCMIC卡保护盖 面板 DDR防尘盖 D-Sub保护盖 高压防尘盖 SD保护盖 Micoro SD卡保护盖 SIM卡保护盖 防水帽盖 帽盖连接带 防水圈 电脑风扇防护盖 电脑风扇防尘座 电脑风扇框护垫 电脑风扇支架 开关遮板 光纤晶体座

电子电脑塑胶五金零件目录

23.插销 铆钉 尼龙铆钉 螺丝铆钉 散热片铆钉 塑料铆钉 电脑风扇铆钉 散热片扣件 弹簧铆钉
螺丝固定座 膨胀螺栓 墙塞 无帽鱼型膨胀管 墙面固定座 石膏板固定座

24.固定扣 门扣开关 机器门扣开关 弹簧固定座 旋转型门扣 门扣碰珠 磁铁门扣

55.工具 线扣工具 进口束线枪 旗型端子工具 国产束线枪 非绝缘端子工具 绝缘端子工具



电子电脑塑胶五金零件目录



1.LED间隔柱



2.LED导光柱



3.LED座



4.90°LED灯座



5.PC板间隔柱



6.塑料铜柱



7.排线固定座



8.PC板端子



9.仪表脚垫



10.塑料螺丝



11.PC板拉柄导槽



12.晶体管盖

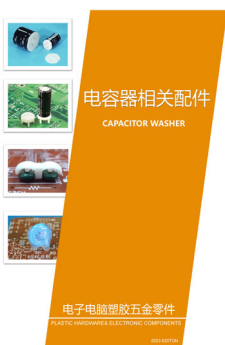

13.电容器垫片



14.热敏电阻座



15.陶瓷零件垫片



16.功率IC盖



电子电脑塑胶五金零件目录



17.孔塞



18.电源线扣



19.机箱把手



20.阻尼齿轮



21.电线扎带



22.USB座护盖

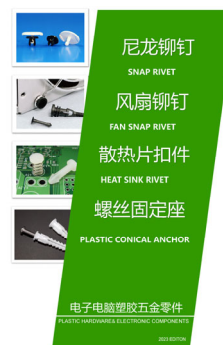

23.尼龙铆钉



24.门扣开关



55.工具



选型手册总目录

本公司保留因质量改进、后续开发或生产要求引起的设计更改权力。本产品目录为元件的详细说明，不能做担保依据。使用者有义务审核该元件是否符合应用范围的规定。



微信



QQ

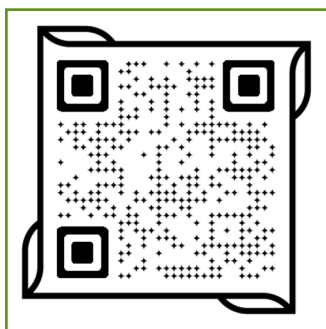

网站

南京诺金电气有限公司

Nanjing Nowking Electrical Co., Ltd

- ◆ Tel: 025-85422485 85436028 85437901
- ◆ Wechat/Mobile :13770725488
- ◆ QQ:260678075
- ◆ E-mail: nk@nowking.com
- ◆ Http://www.nowking.com